Evangeline Series Straight Model

GREENHOUSE INSTRUCTIONS



Manufactured For:
Advance Solar LLC
701 N Duncan Ave
Amite, La 70422
877-238-8357
www.advancegreenhouses.com

JANUARY • 2004

Contents

Foreword	2
User Notes	2
List of Drawings	3
Evangeline Straight Series Component List	4
Foundations	5
Assembly of the Aluminum Frame	
A. Front Gable-End Assembly With Door	6
B. Back Gable-End Assembly	9
C. Sidewall Assembly	11
Aluminum Frame Installation	
1. Side Wall	13
2. Side Wall To Back Gable End	13
3. Side Wall To Front Gable End	13
4. Side Wall	13
5. Ridge	13
5A. Truss Assembly Installation (If Necessary)	See Appendix A
6. Poly bar With Sliders (#1 or #2)	14
7. Vent Frame Angle	14
8. Poly bars	14
9. Tape All Poly Bars	12
8A. Side Vents, Intake Shutter and Exhaust Fan Installation (if necessary)	See Appendices B through F
Polycarbonate And Cap Installation	
General Information About Handling Polycarbonate	20
10. Roof Polycarbonate Panel Installation	20
12. Back/Front Gable Ends	22
13. Sidewalls	22
14. Sealing the Greenhouse to Foundation	22
14A. Sealing the Greenhouse with Silicone	22
Door And Vent Installation	
15. Door Installation	25
16. Vent Assembly	27
17. Vent Installation	27
Appendices: Optional Installations	
Truss	Appendix A
Vent Opener	Appendix B
Intake Shutter	Appendix C
Exhaust Fan	Appendix D
Side Vent	Appendix E
Louvre	Appendix F
Diagonal Brace	Appendix G

Foreword

Your Evangeline greenhouse is designed and constructed to the highest engineering standards and provides structural strength and maintenance-free service for year-round gardening pleasure.

The Evangeline greenhouse must be built upon a firm, level surface. The greenhouse foundation or sill can be made from pre-treated timbers, concrete or bricks. Whatever your choice of material, the base must be square and level.

When selecting a site for your greenhouse, keep in mind that a flat, level site is essential so that the greenhouse can be easily installed and the complete structure is stable and secure. If possible, choose a site with proper water drainage.

Locating the greenhouse in a north-south position is most suitable for raising summer and autumn crops since the sun's rays will be on the greenhouse from daybreak until sunset. An east-west position is ideal for early spring and winter crops since the winter months, with shorter daylight hours, still allow six hours of light exposure to the greenhouse.

Try to locate your greenhouse for easy access, especially to the necessary power and water that is required for greenhouse gardening.

User Notes

The Evangeline greenhouse structure has been designed to withstand extreme weather conditions such as high winds and accumulated snowfall. Hanging baskets and sidewall shelving can also be attached to its sturdy frame. The greenhouse design also makes it possible to add extra sections at a later date.

Sealing the polycarbonate sheets to the aluminum "H" and base is optional, however we highly recommend it. Eliminating any water from entering the inside of the aluminum, will prevent excessive moisture inside the panels.

Once a year the greenhouse needs to be completely washed inside and out. You should do this task when your greenhouse contains the least number of plants, generally just before the garden plants are brought in for wintering over. A recommended cleaning solution is a mixture of soap and water, this will not damage your polycarbonate sheets. Any benches, shelving, plastic trays, pots and baskets should also be cleaned thoroughly. *Prevention is the best known method for controlling pests and diseases in the greenhouse.*

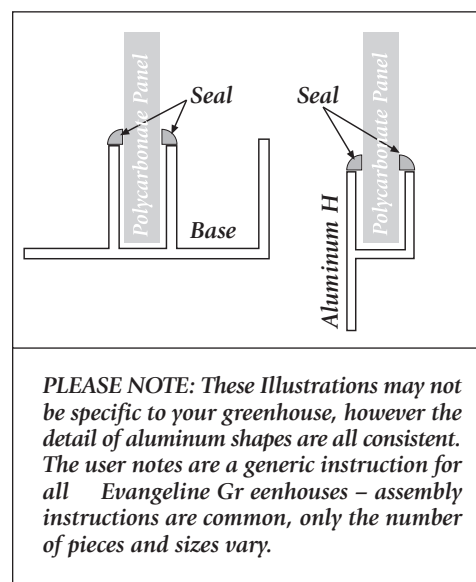

PLEASE NOTE: These Illustrations may not be specific to your greenhouse, however the detail of aluminum shapes are all consistent. The user notes are a generic instruction for all Evangeline Greenhouses – assembly instructions are common, only the number of pieces and sizes vary.

NOTE: DO NOT STORE POLYCARBONATE SHEETS IN THE SUN.

List of Drawings

Foundation Styles	5
Front Gable End (With Door) Inside View Line Drawing Assembly Procedure	7
Front Gable End (With Door) Inside View Detail Drawing – <i>Details 1-8</i>	8
Back Gable End Line Drawing Assembly Procedure	9
Back Gable End Detail Drawing – <i>Details 9-12</i>	10
Assembly Outline Steps 1 – 9	15 - 16
Steps 9A	See Appendixes
Steps 10 – 13	20 - 22
Door Installation	25
Vent Assembly - Exploded View	27
Vent Detail	29
Truss Assembly	Appendix A
Vent Opener	Appendix B
Intake Shutter	Appendix C
Exhaust Fan	Appendix D
Side Vent	Appendix E
Louvre	Appendix F
Diagonal Brace	Appendix G

Evangeline Component List

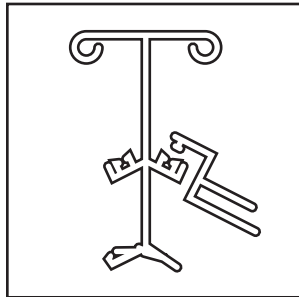

Ridge & Ridge Slider

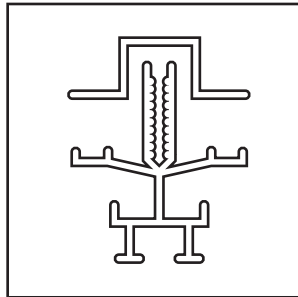

Poly Cap & Poly Bar

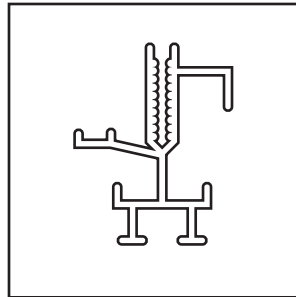

Poly End Bar

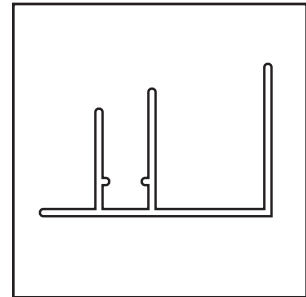

Ventframe Bottom Side Base/Sill

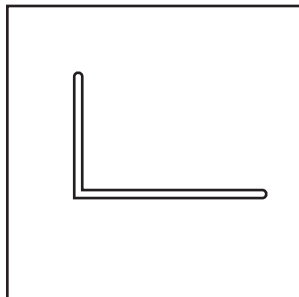

Bracing Angle

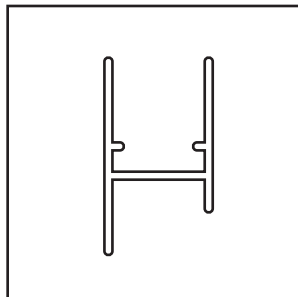

Aluminum H

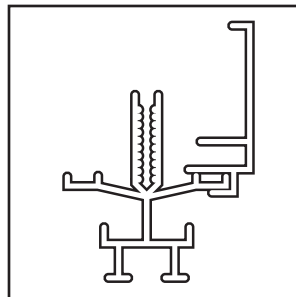

Vent Frame Sides

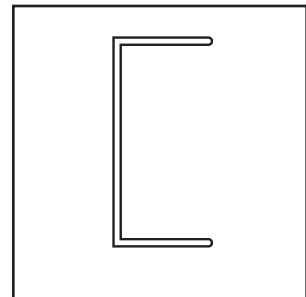

Purlin



Bolts / Nuts / Screws

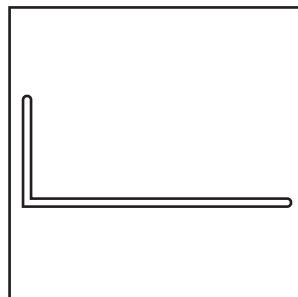

Front & Back Base/Sill

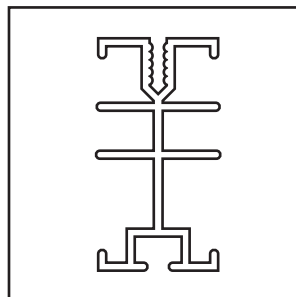

Door Frame

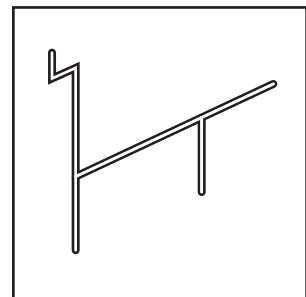

Gutter

Tools

- | | |
|---|---|
| <input type="checkbox"/> #2 Square head screw driver (#8 Screw) | <input type="checkbox"/> 7/16" wrench |
| <input type="checkbox"/> Measuring tape | <input type="checkbox"/> Razor blade cutter |
| <input type="checkbox"/> Level to check foundation | <input type="checkbox"/> Caulking gun |
| <input type="checkbox"/> 3/16" concrete bit (concrete foundation) | <input type="checkbox"/> Ladder |
| <input type="checkbox"/> 9/64" aluminum bit | <input type="checkbox"/> Hammer |

Optionals

- Automatic Opener
- Circulating Fan
- Max/Min thermometer
- Benches
- Eyebolts
- Motorized Intake Shutter
- Exhaust Fan
- Thermostat
- Heater
- Side Vent

Foundations

Check your local building codes for foundation requirements in your area.

CONCRETE FOUNDATIONS

When you prepare the concrete foundation, the size should be 1" longer and wider than the greenhouse's outside dimensions. One option is to fasten a treated 4" x 4" wooden sill on top of the foundation. This sill is the exact outside dimensions of the greenhouse.

PRE-TREATED WOOD FOUNDATIONS

A greenhouse that is approximately 100 sq. ft. (9.3 m²) can be fastened to a 4" x 4" pre-treated wood timber foundation. For larger greenhouses, a 6" x 6" wood timber foundation is recommended. These timbers are placed on a 4" (10 cm) deep and 8" (20 cm) wide gravel bed. Wood timbers can be stacked to increase the height of the greenhouse. *One advantage of the wood foundation is that it is not classified as a permanent structure. Therefore, if you move, the greenhouse can be dismantled and moved to another location.*

A SQUARE AND LEVEL FOUNDATION

Check the width and length of the foundation's outside dimensions. Then, square the foundation by measuring diagonally from opposite corners in the form of an "X". Next, use a long carpenter's level to check and adjust the foundation until it is level. Finally, measure where the door will be placed (in most cases it is 34¹/₂" wide). Mark these measurements on your foundation.

Foundation Styles

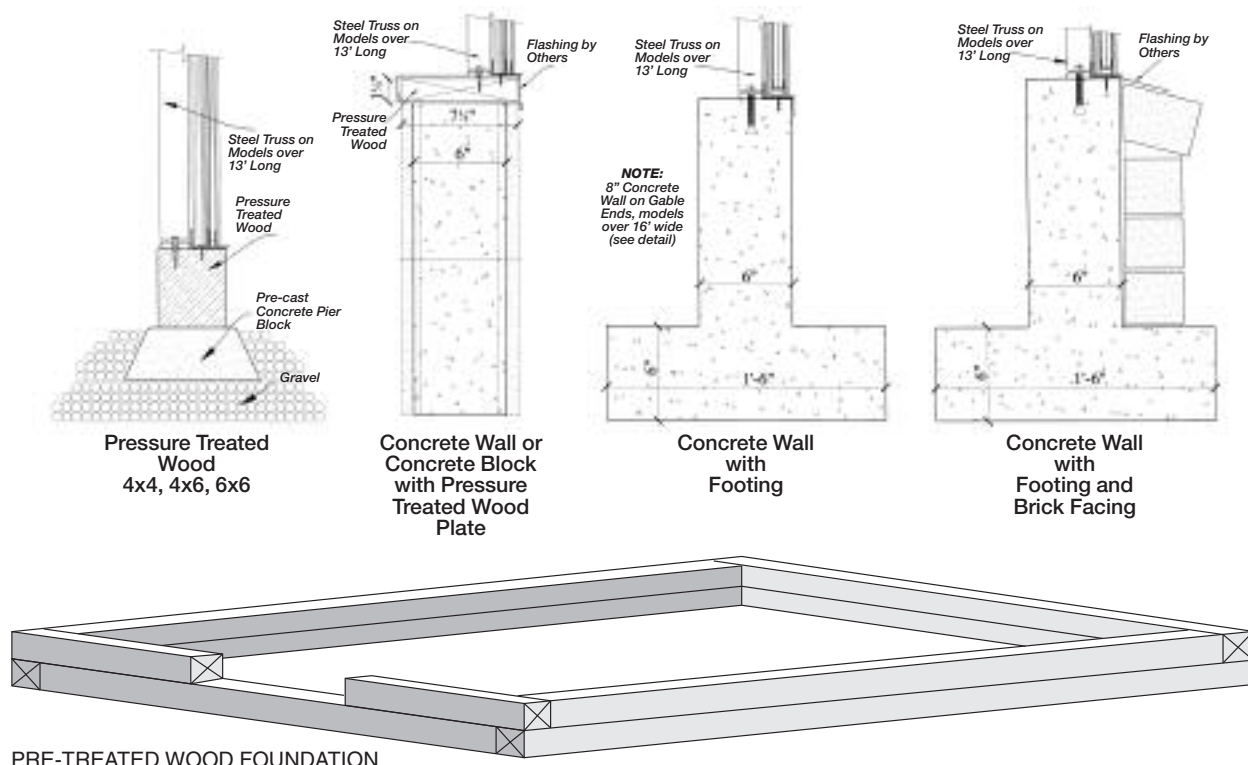

PRE-TREATED WOOD FOUNDATION

Assembly of the Aluminum Frame

A. FRONT GABLE-END ASSEMBLY WITH DOOR

Lay out the front pieces of the greenhouse into the shape of an end wall. The doorframe and Poly Bars have a track for the bolt. The track must face up when you assemble the gable ends. Slide the bolts in the track of the bars or use the notches that have already been punched out in the bars. When you are assembling the greenhouse, you view the sketches and drawings from inside the greenhouse (*see page 7 for line drawings and page 8 for detail pictures*).

1. Bolt the bottom plates (4 holes) to the base/sill and the doorframe sides using 1/4" x 1/2" stainless steel bolts (*line drawing #1, page 7*) (*see detail #1, page 8*). Before tightening the bolts, be sure that it is square. (*If you ordered a greenhouse with a door drop, measure from the bottom of the doorframe to the underside of the base according to the specified distance.*)
2. At the top of the doorframe, put on the doorframe header (*which looks the same as the side pieces*). Put the header *between* the two side pieces and bolt on the plates (6 holes) (*line drawing #2, page 17, detail #2, page 8*). The plates should stick up 1" above the doorframe. Note how the plates are put on (*See detail #2*). Before tightening the bolts, be sure to square up the doorframe.
3. Take all the Poly Bars and bolt them to the base/sill. The angle cut should match the roof slope (*line drawing #3, page 7, detail #3, page 8*).
4. The 1" x 2" angle above the door (50" long) can now be bolted on. The 1/4" round holes should be lined up with the holes in the plates. Each end of the 1" x 2" angle has a slot punched out to accommodate the bolt that is lined up with the Poly Bars 24 1/2" from the center. Slide a bolt in the top of the Poly Bar and fasten the angle to it. (*line drawing #4, page 7, detail #4, page 8*).
5. Each Poly End Bar has at least one small aluminum piece attached to it with a 1/4" hole punched in it. These pieces line up with the upright Poly Bar(s). Both sides are the same.
6. When both Poly End Bars are fastened, bolt on the short center bar above the door to the angle above the door. Do not worry about the small cleat bolted on the bar. This will be used later. (*line drawing #5, page 7, detail #6, page 8*).
7. The diagonal bracing can now be bolted on. Remove the bottom nut in the top plate and insert the brace. Then put the nut back on (*See detail #7, page 8*). There are 1/4" holes in the base, so use 1/4" x 1/2" bolts (*line drawing #7, page 7, detail #8, page 8*).

Be careful when you stand up the front end of the greenhouse because the poly end bar is quite loose. It may have only two bolts in it.

NOTE: *Temporary door frame spacer can be fastened to the bottom of door frame using a strip of wood. Make sure that the spacing is the same as the top of the door frame. This will keep the door frame from pulling apart when you pick up the end and move it around.*

Front Gable End (with door) Line Drawing Assembly Procedure

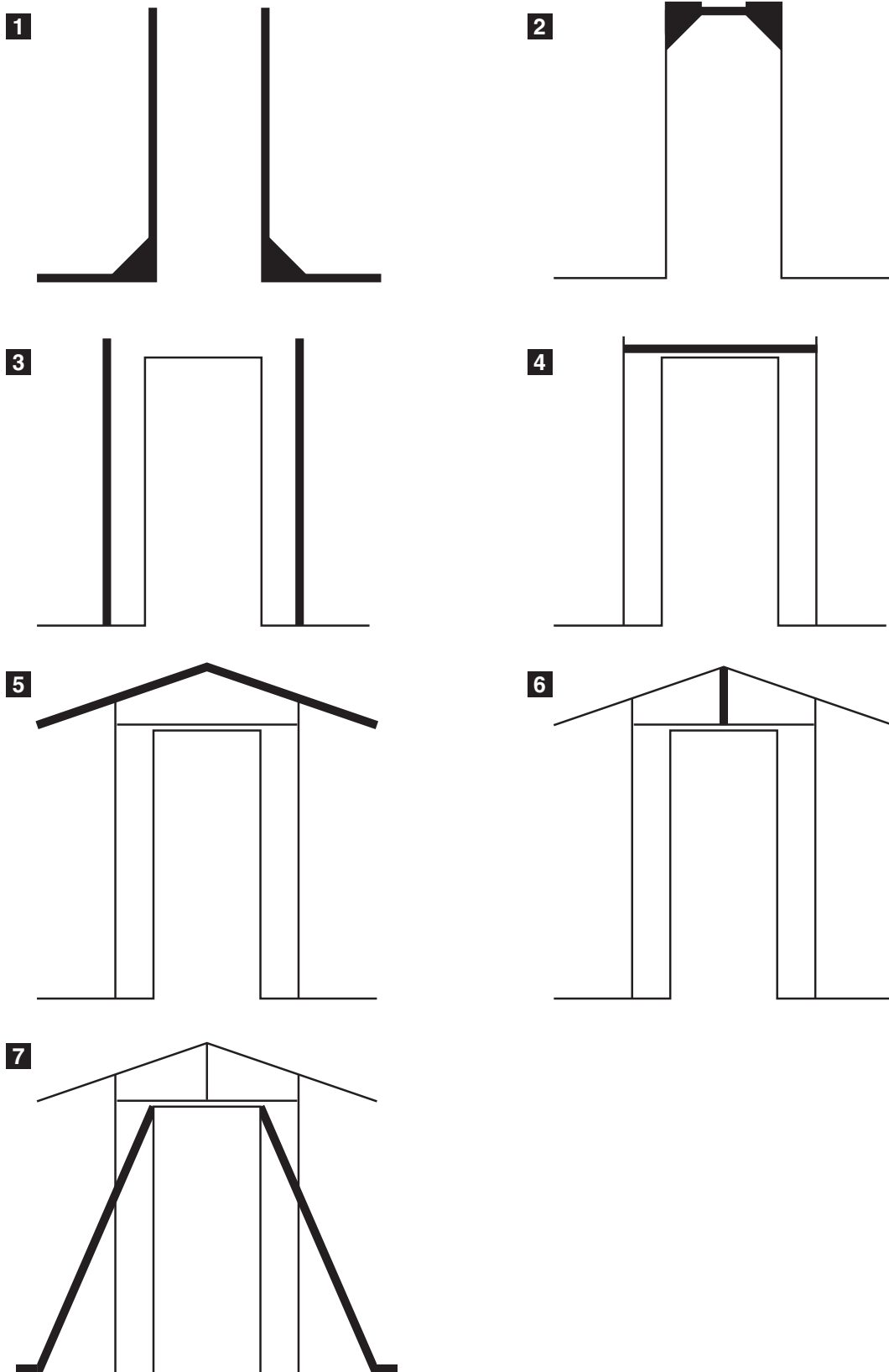

*Front Gable End (with door) Inside View Detail Drawings
Details 1-8*

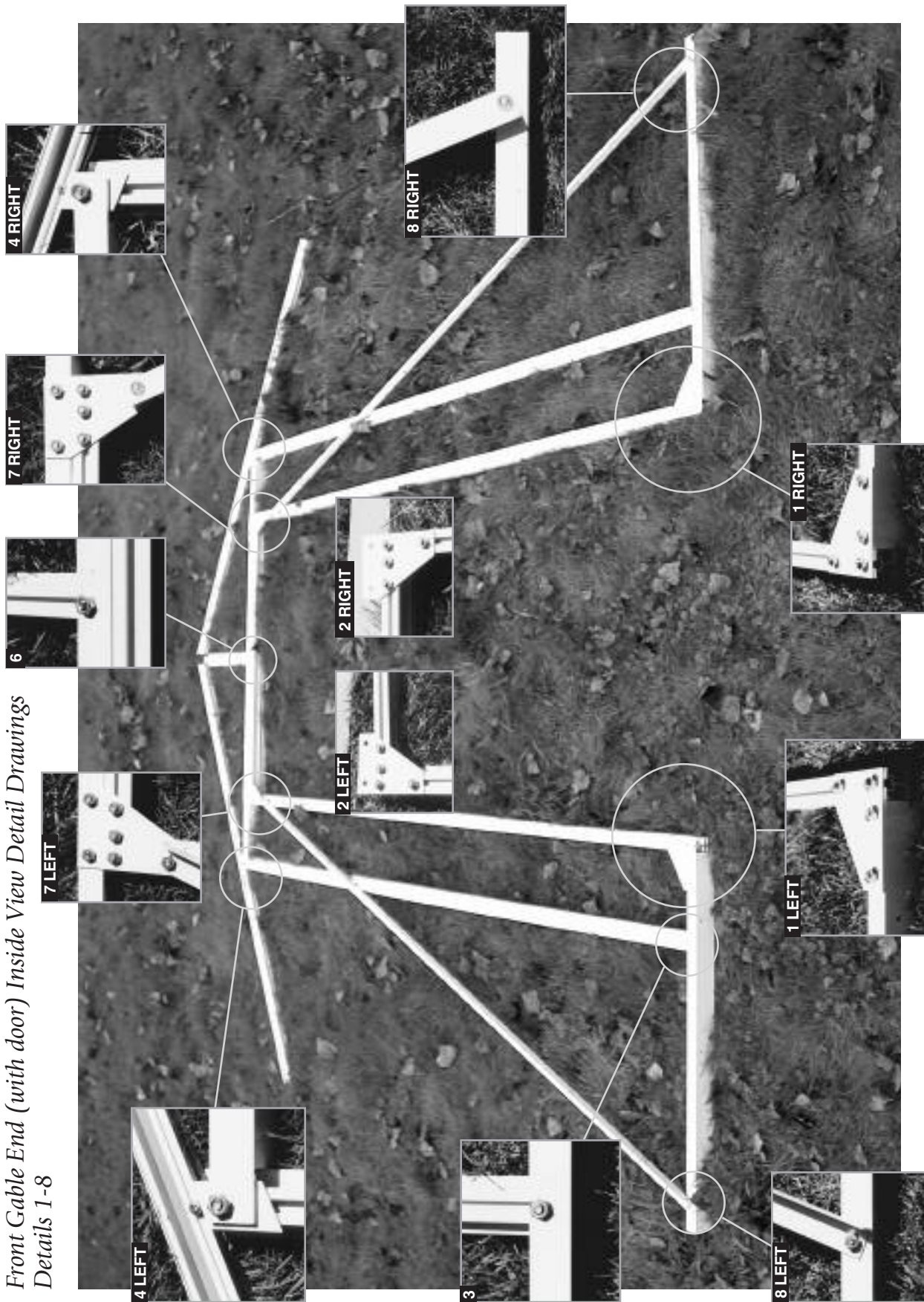

B. BACK GABLE-END ASSEMBLY

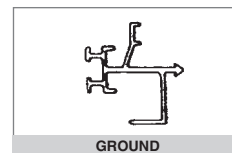

Lay out the back pieces of the greenhouse into the shape of the end wall (*Refer to the line drawings page 9, detail pictures page 10*). For the Poly End Rafter Bars, the flat surface should lie on the ground.

1. Bolt the bar / sill to bottom of Poly Bar (*Detail #10, page 10*).
2. Fasten the upright Poly Bars to the Roof Poly End Bar using 1/4" x 1/2" bolts (*Roof Poly End Bars have at least 1 small angle attached to it. Detail #9, page 10*).
3. Cross brace angle is bolted approx. 54" from the base. At this time it is not important to be exact. When the greenhouse gets assembled you will see the height of the cross brace by attaching the end of it to the angle that is attached to the corner Poly Bar (*Detail #11, page 10*).

Back Gable End Line Drawing Assembly Procedure

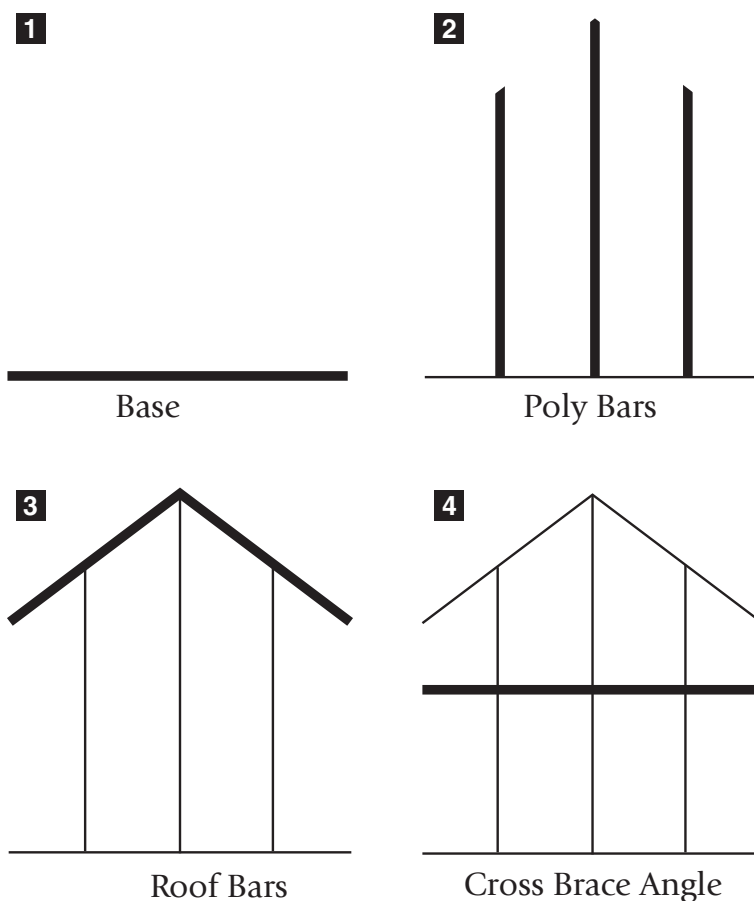

Back Gable End Inside View Detail Drawing – Details 9-12

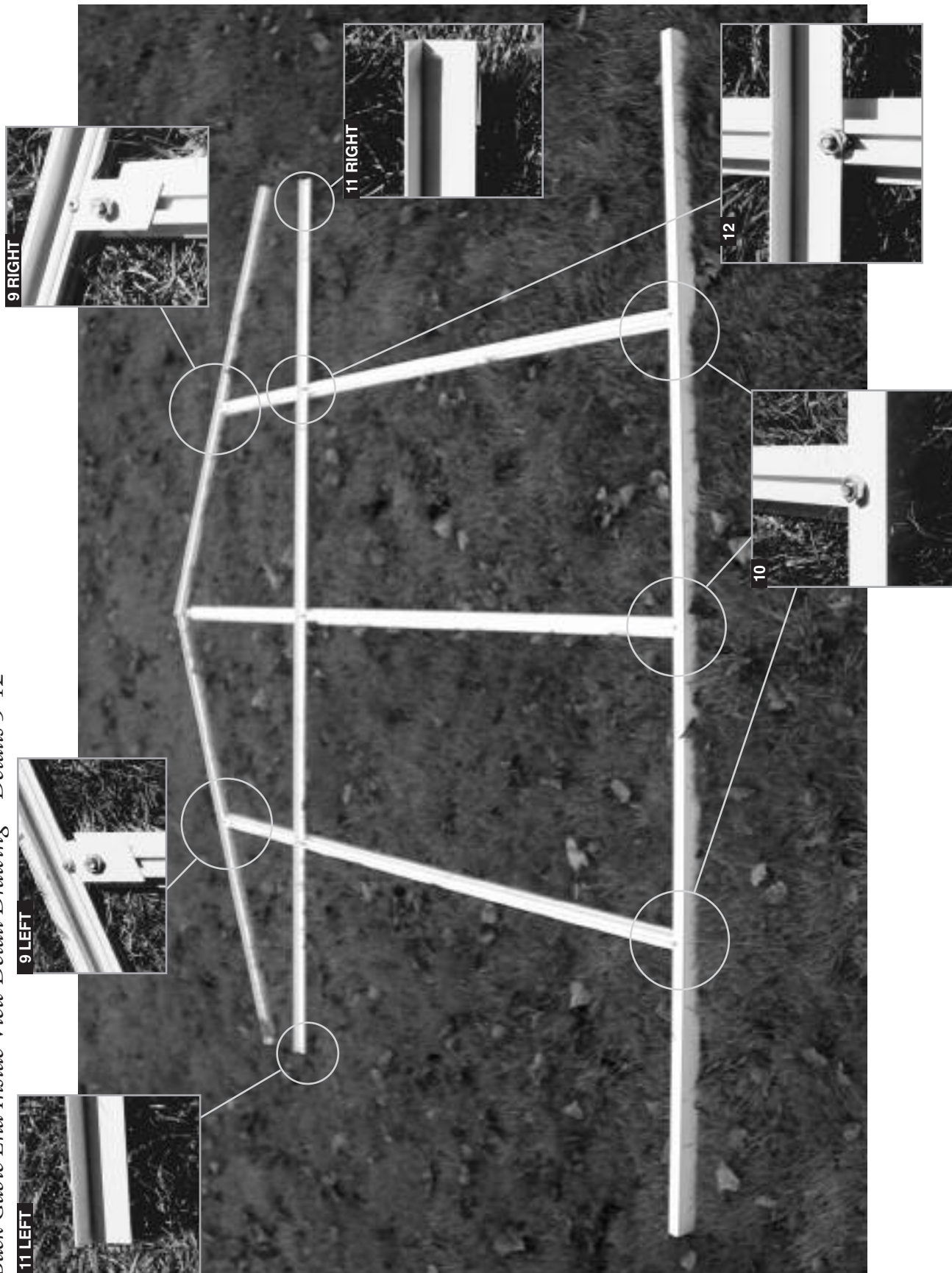

C. SIDEWALL ASSEMBLY

Each sidewall includes gutters, bars and sidewall Poly Bars.

1. Lay out the sidewall with the gutter at the top, the base at the bottom, and the sidewall Poly Bars with the bolt track facing up (*See the sidewall drawing assembly procedure*).
2. Each sidewall Poly Bar has a straight cut and an angle cut. The straight cut fits into the base/sill and the angle end faces the gutter.
3. The corner post, with an angle attached to it, is for the backwall (*If you put it in the wrong end, don't worry, you can change it after the greenhouse is bolted together*). Fit the cornerpost into the base/sill. Then drop the bolt into the notch and fasten it to the base.
4. Push the Poly Bar up and tighten all the bolts to the gutter. Do the same with the base
5. For the other sidewall, follow the same procedure, but notice that the cornerpost *(with the angle attached to it)* will be at the opposite end (*Remember always to face the bolts slot in the Poly Bar towards you*).

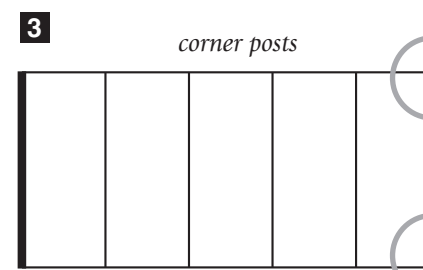
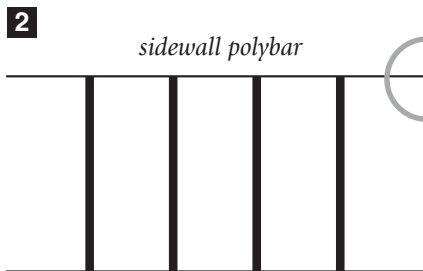

9. TAPING POLY BARS WITH FOAM

Tape all the aluminum Poly Bars with a 1/8" foam gasket. Tape the poly end bars on one side only (See Detail #14). Tape all the other Poly Bars on both sides (See Detail #13). Take a roll and, starting at one end, press it on the bar. Make sure that the aluminum is dry. (You should move all the pieces into a shed or undercover if it is raining.) Slowly roll down the tape toward the outer edge and press it down at the same time. (See Details #14A & B.) Be careful because sometimes the edge of the paper is quite sharp. Do not remove the paper until later. Do not tape where the Poly Bar is notched out. (See Detail #15.)

NOTES: Taping can also be done either before (as shown in pictures to the right) or after the greenhouse is assembled.

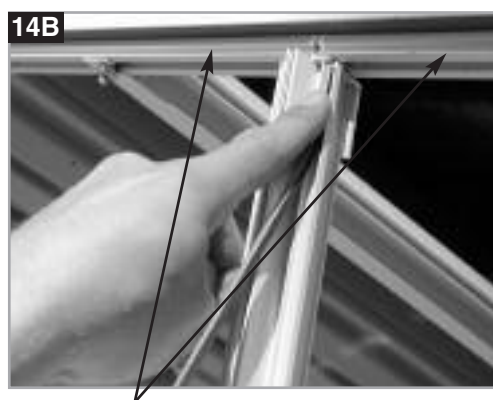

Do **NOT** put foam tape along the End Bars. The polycarbonate slides under the lip and needs to be sealed when the greenhouse is finished

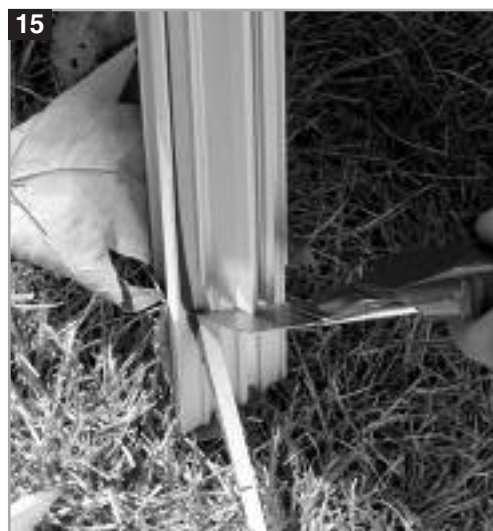

Aluminum Frame Installation

Check that the foundation is level and square. If your foundation is larger than the greenhouse, mark a line on it with a pencil or with a chalk line. Take a caulking gun and put in a tube of caulking. Cut 1/4" off the top at a 25-degree angle. Then put a bead of caulking on your foundation approximately 1" in from the outside of the foundation or the marked line. **DO NOT CAULK THE DOOR OPENING.** Measure your door opening in the front.

NOTE: *When you are ready to assemble the greenhouse, an extra person is required (2 extra would be great - you would not need to brace or fasten the greenhouse to the base at this time).*

1. SIDE WALL

Stand up the SIDE WALL (brace back end with a ladder or a side brace), or you can fasten the side wall down with #8 x 1" screws, make sure that it is square on your foundation. *(See Step 1 Detail, page 15)*

2. BACK GABLE END

Take Back Gable End, set it on the foundation, push the base against the side base and bolt the Roof Poly End Bar to the gutter. Fasten it to the foundation *(See Step 2 Detail, page 15)*

3. FRONT GABLE END

Do the same to the Back Gable End *(measure the door opening on the top and bottom before fastening it to the base)* *(See Step 3 Detail, page 15)*

4. SIDE WALL

Stand up and bolt on the Roof Poly End Bars *(See Step 3 Detail, page 16)*

5. RIDGE

Take the ridge (one person at each end) and slide it between the end bars on the top. You will notice the punched-out slots in the bottom flange of the ridge. The end slots must line up with the bottom side of the Roof Poly End Bar. Before you slide in the ridge, put one bolt in the top of each Roof Poly End Bar. Now slide in the ridge and slide the bolt into the ridge slot. Make sure that the Roof Poly End Bar. bar is tight against the ridge. *(See Step 5 Details, page 16)*



5A. SEE APPENDIX A FOR TRUSS ASSEMBLY INSTALLATION, IF REQUIRED

6. POLY BAR WITH A SLIDER (#1 - #2, etc.)

Each Poly Bar is marked with a number to correspond with the number on the ridge. Slide the bolt into the top of the Poly Bar and line it up with the slot in the ridge. Move up the bolt and fasten it tight against the ridge. Do the same for the bottom of the Poly Bar. Slide in the bolt, lay it on the gutter and bolt it on. Do this for all the Poly Bars with sliders and numbers. Make sure that the bar is tight against the bottom of the gutter. *(See Step 6 Detail, page 17)*

7. VENT FRAME ANGLE

The vent frame angle is 50" long with the ends cut out to fit between the two Roof Poly Bars with sliders. The vent frame is the same shape as your base/sill. Put the head of the bolt into the punch out (24" from the top), slide the bolt up and fasten it to the vent frame on the bar. Make sure that the angle flanges are facing the sidewall (down) and that it is pushed tightly against the sliders. Do this for all of them. *(See Step 7 Detail, page 18)*

8. POLY BARS

Bolt on all the remaining Poly Bars. Make sure that the top and bottom are tight against the ridge and gutter. *(See Step 8 Detail, page 19)*

9. TAPE ALL POLY BARS

You are now ready to tape on the 1/8" foam gasket, if you have not done this already. *(See instructions on page 12)*

9A. SIDE VENTS, INTAKE SHUTTER AND EXHAUST FAN INSTALLATION (if necessary).

(See Appendixes A through F, then return to the next page and continue)

– Assembly Outline –

Step 1: Bolt Side Wall to Back and Front Gable Ends

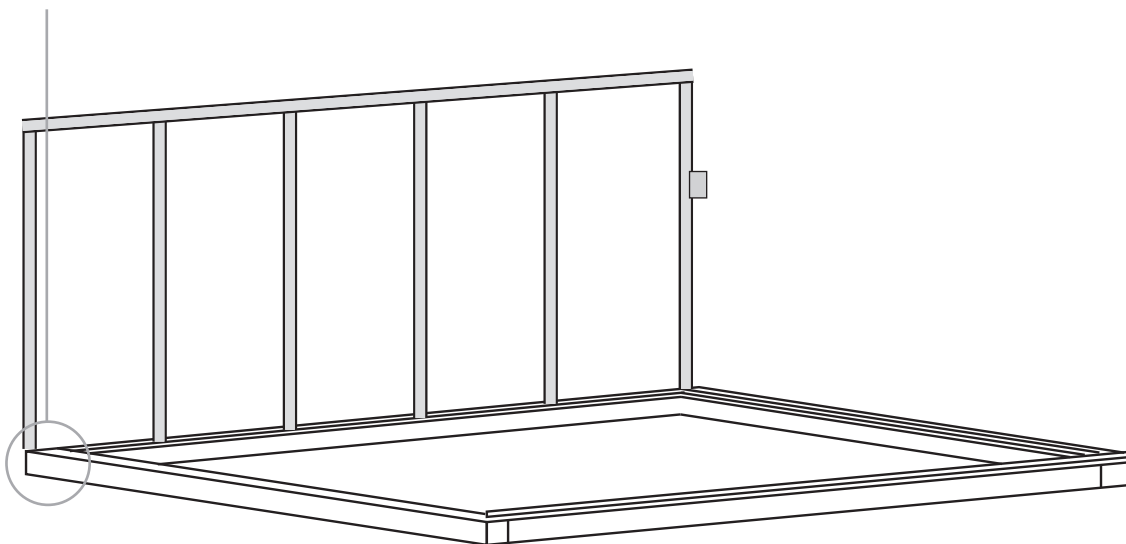

Step 2: Back Gable End

Step 3: Front Gable

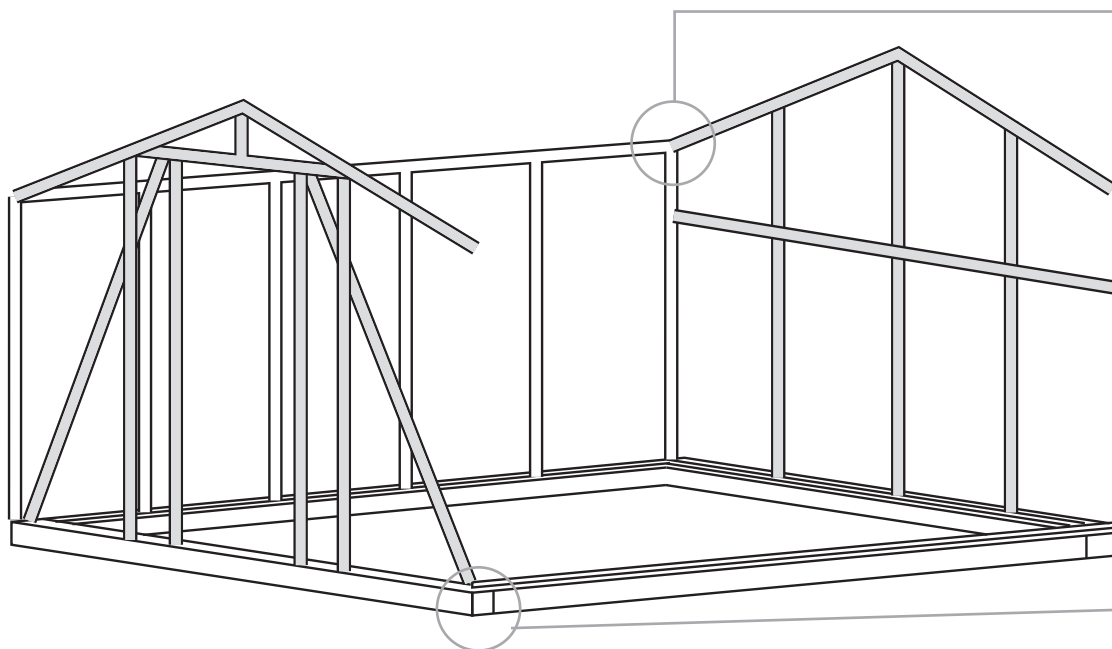

(shown from the back)



Step 4: Side Wall

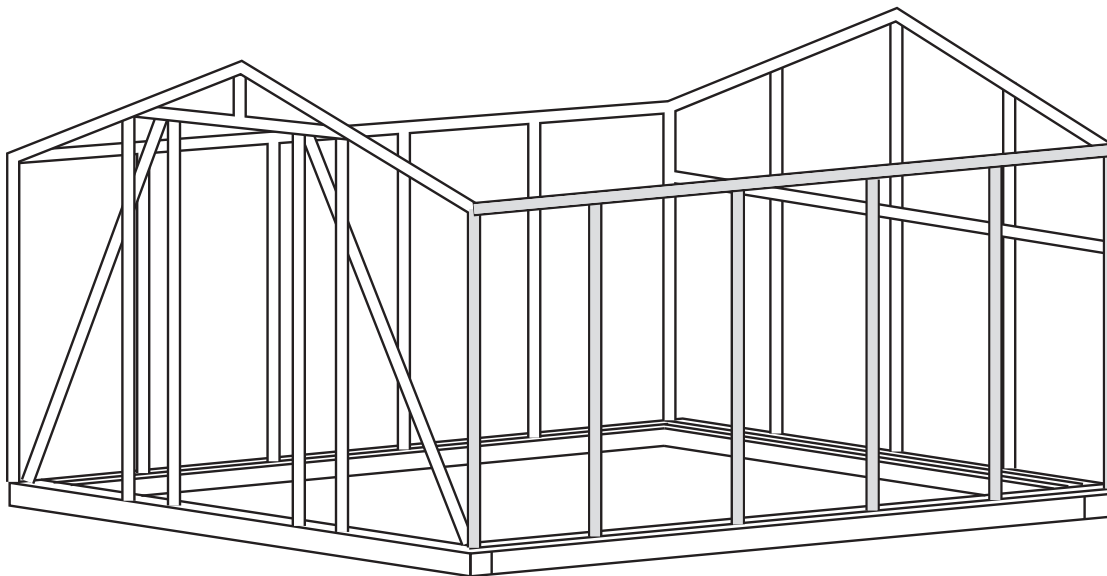

Step 5: Ridge



Front View

Inside Back View

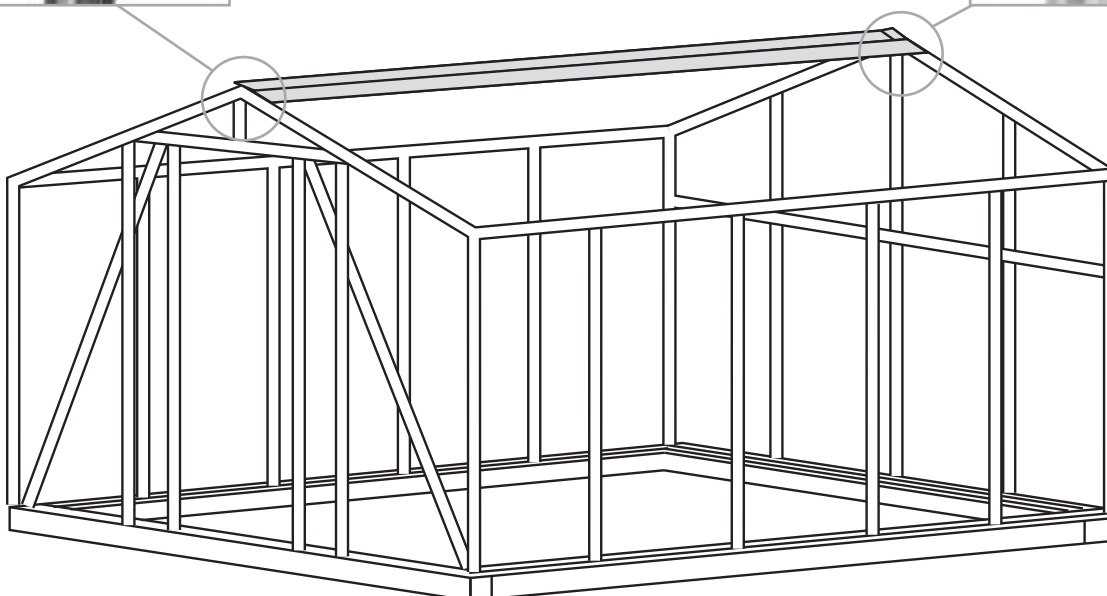

Step 6: Roof Polybar with Vent Frame Siders

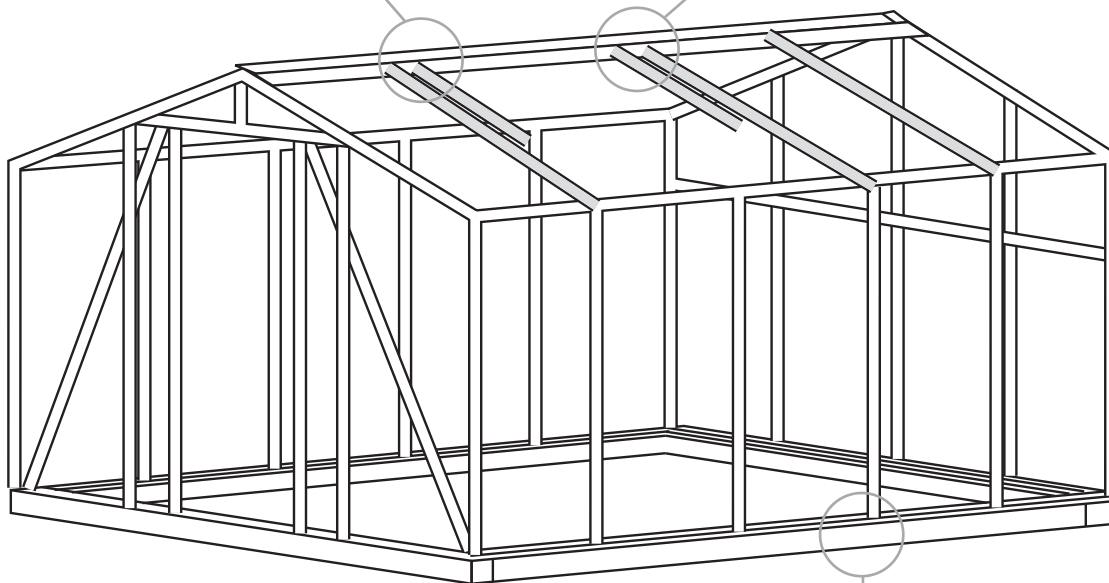
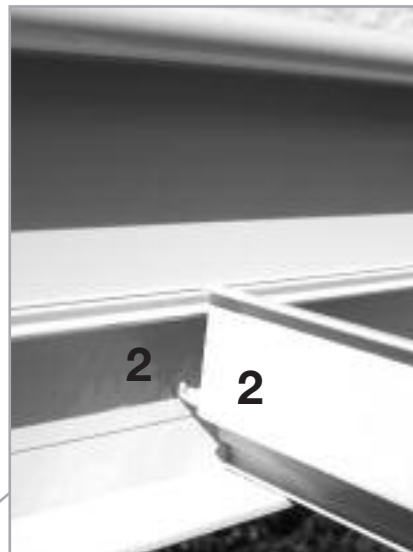

Step 7: Vent Frame Bottom

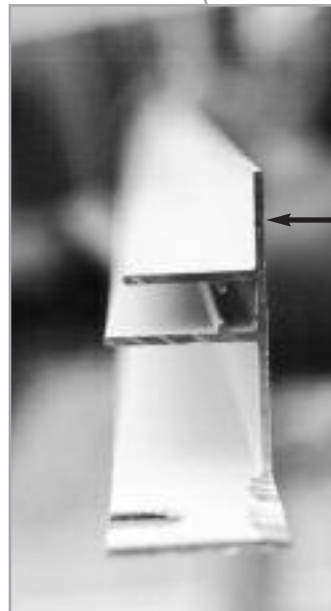
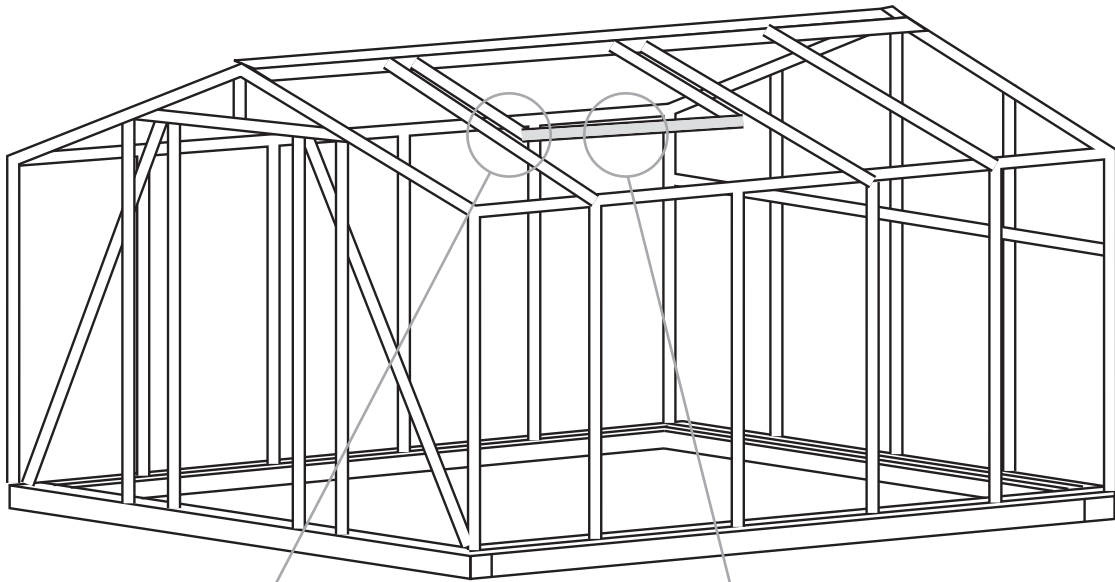

This flat side faces towards the ridge.

Step 8: Install all remaining Roof Polybar

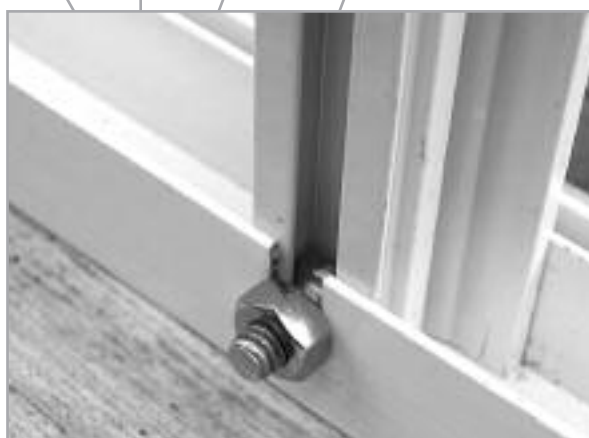
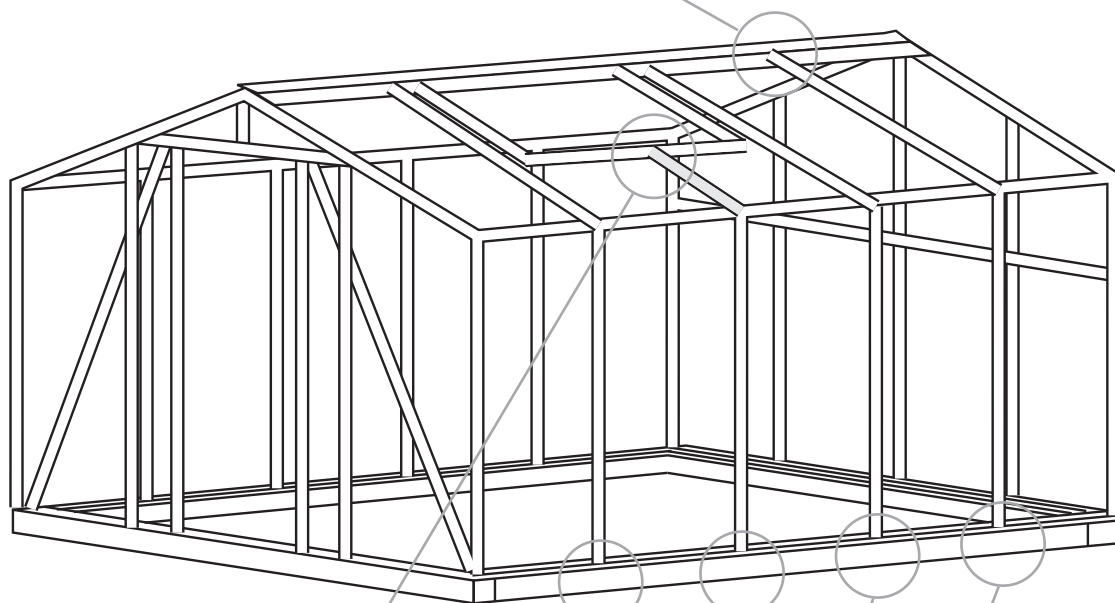

Polycarbonate Panels & Cap Installation

GENERAL INFORMATION ABOUT HANDLING POLYCARBONATE

All polycarbonate sheets are covered with a thin sheet of plastic on both sides to prevent the sheets from becoming dirty and scratching during handling. One side is a clear plastic while the other side is blue or some other colour, depending on the manufacturer. This latter side should be installed so that it faces out. (**VERY IMPORTANT: The sheet is marked to indicate which side should face out.**)

Before you begin installing, lay out the sheets lengthwise so that it is easier to take the one you want to install. Do the same with the capping.

Remove all the paper on the foam strip on the greenhouse before you begin installing the panels. If the weather is warm and sunny, the foam strips will be sticky. Take a trigger spray bottle and fill it with soap and water. Just before you install the panels, spray the foam lightly so that the panels can be moved around.

(Do not store polycarbonate bundles outside in the sun. Instead, store them in a cool dark place, such as a garage, until you are ready to use them.)

10. ROOF POLYCARBONATE PANEL INSTALLATION

NOTE: When you install the roof panels, start on the far side of the roof vent opening. Work towards the vent opening. When installing the last pieces in the roof you can reach it through the vent opening and do not have to move your ladder outside.

Start with the roof panels. Peel off the plastic. (See Picture 1, page 21) Remember to mark the corner so that you know which side is out (The blue plastic indicates the outside; the clear plastic indicates the inside).

Put an aluminum "H" on the bottom of the sheet (Picture 2, page 21). Then slide the panel into the top track (Picture 3) and the bottom of the panels with the "H" into the gutter. The long leg of the "H" faces outside (Picture 4). (The gutter should have NO foam on the ledge where the lip of the "H" rests) If the Poly Bars do not line up with the panel, move the greenhouse ridge toward the front or back until the bars line up. This "squares up" the roof section. Spray the foam if it is sticky. The shorter pieces should be placed under the vents. Finish the one side of the roof.

Take the cap, hold it against the panel and position it in the center of the Poly Bar (Pictures 5, 6 & 7). Use #8 x 1/2" screws and screw it on the Poly Bars (You could use a portable drill with screwbit to do this job, just don't make it too tight). Continue to the next panel and follow the same procedure.

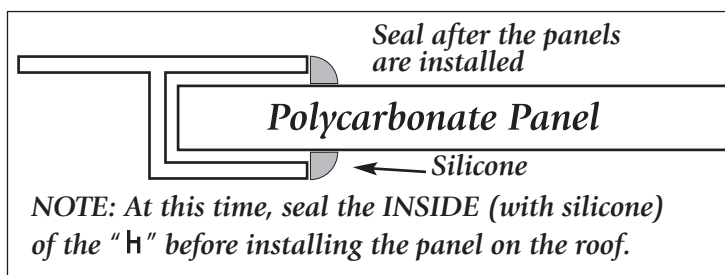

Step 10: Roof panels

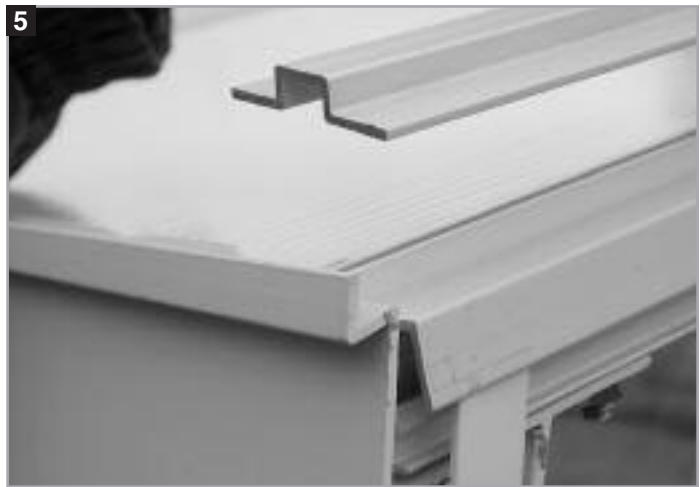
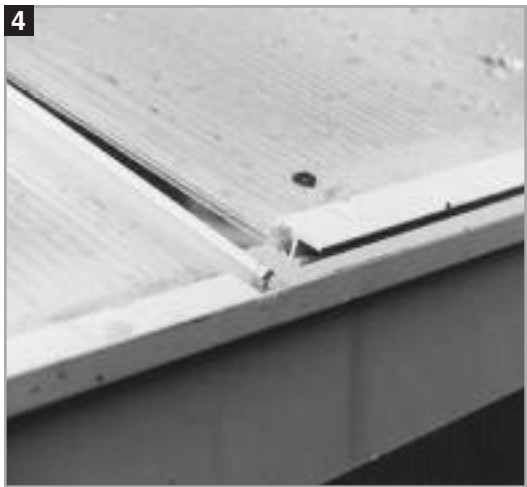

12. BACK/FRONT GABLE ENDS

Remove the corner posts (*Picture 13, page 23*). Take the corner gable end polycarbonate panel and place an aluminum "H" on the bottom (*Picture 12, page 23*). Stand up the sheet on the base/sill between the upright Poly Bar and the corner. Then bend the panel and slide it into the top. *Spray the foam if it is sticky.*

Re-install the corner post by sliding it along the side of the polycarbonate panel and bolting it to the base/sill and gutter (*Picture 10, page 23*). The "H" slips snugly into the corner post at the base/sill. You can install all the polycarbonate panels before putting on the caps.

The polycarbonate panel beside the door needs an aluminum "H" on the top and bottom. Slide the panel into the doorframe (*Picture 11, page 23*) and push it into place.

13. SIDEWALLS

Once the polycarbonate is installed in the roof and gable ends, proceed to the sidewalls.

Spray the foam if it is sticky. Stand the sheet up into the bottom track of the side base/sill. Put "H" on top of the panel (*see sketch to the right*). Bend the panel and slide the top of the panel behind the gutter edge. Push the panel against the foam and screw on the caps in the same manner as you did the roof and gable ends.

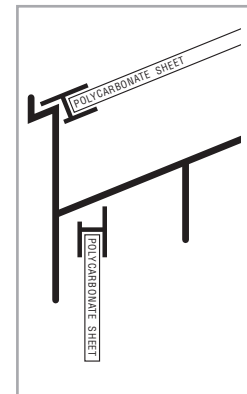

14. CAULKING THE GREENHOUSE

If you are not able to do it earlier (See page 13), caulk the inside of the greenhouse along the base. When the foundation is larger than the greenhouse, do the outside also.

NOTE: Seal the aluminum angle to the greenhouse foundation only – do not use caulking to seal the polycarbonate sheets.



Steps 12 – Polycarbonate Installation

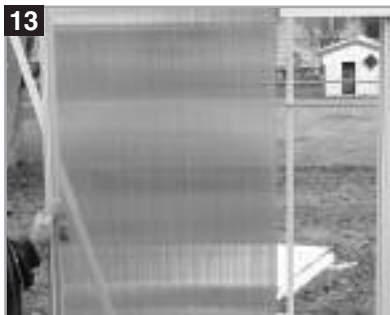

Steps 13 – Side Walls

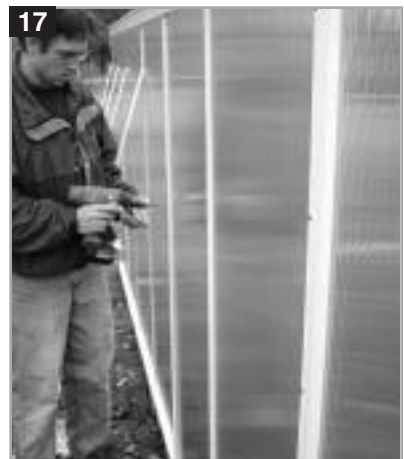

14. SEALING THE GREENHOUSE

When all the polycarbonate sheets are installed, take a tube of clear silicone sealant and seal all the panels that fit into the aluminum tracks on the top, the bottom, the inside and the outside. In this way, you can keep out most of the moisture from the end of the panels. If this sealing process is not done, water may sit in the bottom and fill the inside of the panels and grow algae.

1. Unscrew the plastic nozzle on the tube of silicone sealant.

2. Cut the top of the tube.

3. Screw on the plastic nozzle again.

4. Cut approximately 1/8" off the end of the plastic nozzle at a 30-degree angle.

5. Put the tube into the caulking gun. When using the gun, squeeze the handle slowly.



6. Wherever the polycarbonate sheets are sitting in a track or aluminum "H", seal the edge, including the end poly bars. Also seal the inside of the sidewalls because greenhouse humidity runs along the walls and into the bottom track.

7. Seal the vents before you slide them into place. Seal the places where the panels fit into the door frame bar and the "H" under the above door angle.



Inside view



Outside View

CAULKING / SEALING

- Seal the door frame bar where the base/sill meets the door frame.
- Seal the inside of the base/sill along the perimeter of the foundation.



Roof

15. DOOR INSTALLATION

(Refer to the drawing.) Take the door and set it inside the door frame. Lift it up as high as possible on the hinge side and put the screws through the existing holes in the door frame. Now the door will hang by itself.

Remove the black clip from the "Z" bar and put one screw into the door frame to hold the "Z" bar. Open the door, take off the clips and put back the screws. Close the door and check that it is square. If the frame and the door are square, then fasten the "Z" bar to the frame. If not, move the "Z" bar up or down to square it. If this is not enough, loosen the bolts in the top plates and move the frame to make it square. When it is in place, tighten all the bolts.

Next install the door handle (see the instructions inside the box). To install the door catch angle, slide in two bolts into the back of the door frame. Bolt on a small angle (provided with the door handle). Face the angle towards the door, line it up with the center of the door handle, and then tighten the two bolts (see picture to the right). Take the door catch out of the door handle box and screw it on. Close the door and adjust the door sweep at the bottom of the door to eliminate potential gaps.

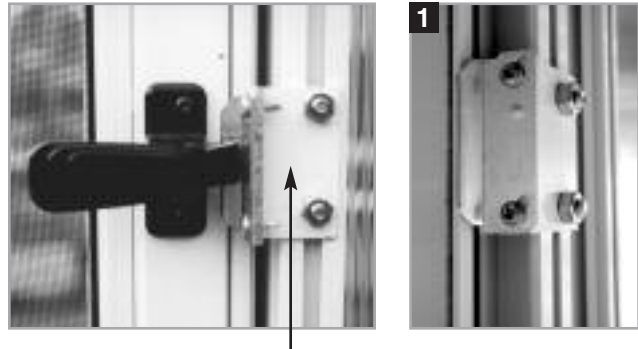

Door Catch Angle

NOTE: There are two types of manufactured doors. The door catch angle on the white door may have to be turned the opposite way as shown on picture **1**.

Run a bead of silicone under the angle above the door and against the door frame. Also silicone the "H" on the polycarbonate beside the door to ensure an airtight seal.

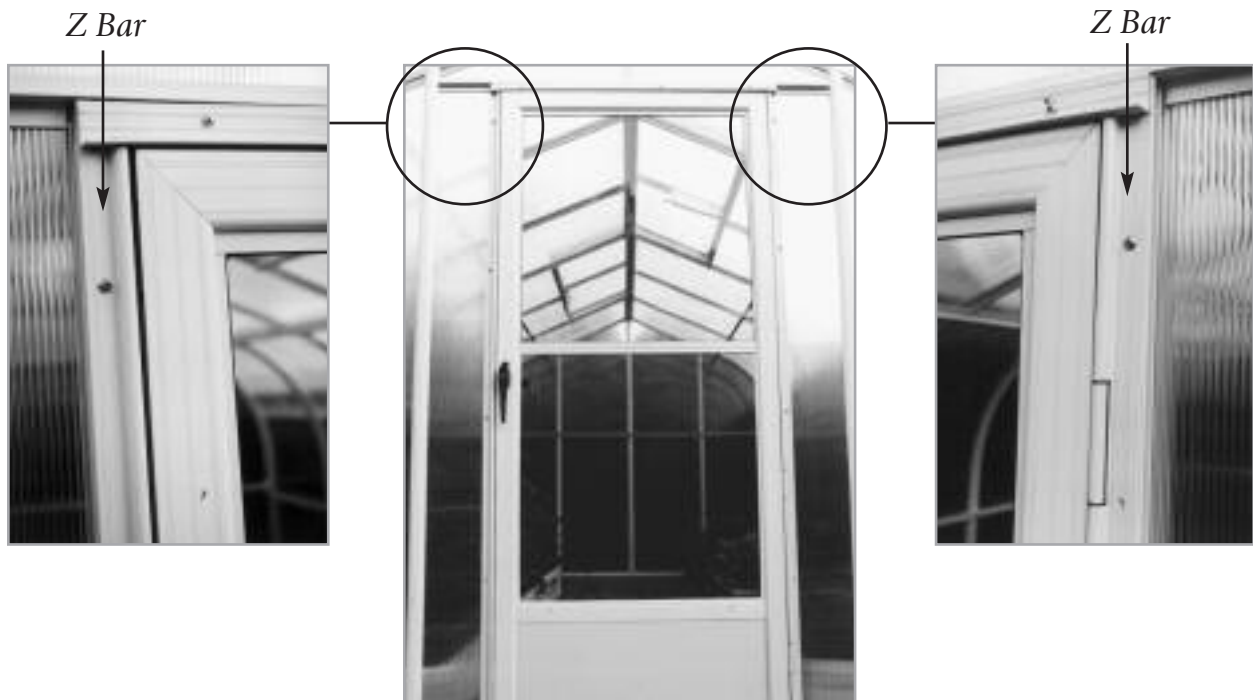

Door Installation

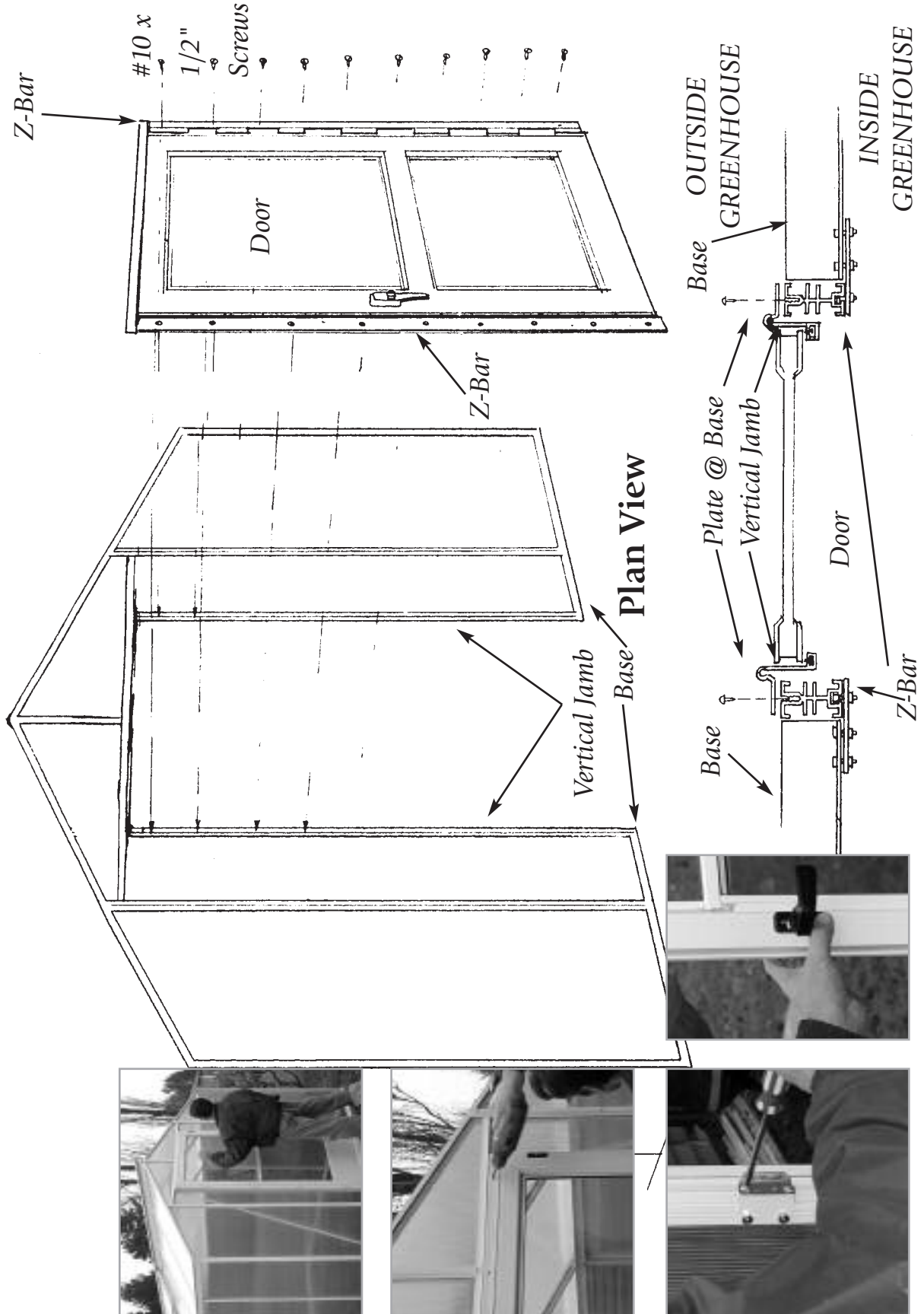

16. VENT ASSEMBLY (SEE DRAWING & PICTURES PAGES 29 & 30)

1. Lay down the gutter with the punches facing up towards you.
2. Polybars with sliders on are for the end. Lay them down with the bolt slot facing up.
3. Hinge with punches facing up towards you.
4. Slide the bolts into both ends of the end bar. Take the gutter and line up the bolt with the 1st punch, slide the bolt down and tighten it. Do the same with the hinge, other side and center bar. Make sure that the polybars are tightly fitted to the gutter and hinge after vent assembled.
5. Turn it over and put a square where the polycarbonate goes. Shift to square.
6. Put 1/8" foam on the polybars.
7. Take polycarbonate panel, remove the film (*clear inside*) and slide it into the hinge track. Before you do this; remove the paper and lightly spray the foam so that it doesn't stick. Lay it on the foam and slide it into the hinge (top) section and then down into the gutter track. Do the same with the next piece.
8. Take the caps and lay them on the bars, center them, fasten with 1/2" screws.
9. Take the silicone gun and seal where the sheets slide into the track. *Inside and out.*

17. VENT INSTALLATION

Take the vent and slide it in the end of the ridge. You will have to remove a the screw in the ridge. Then push it into place and put the screw back in. Now attach manual opener (*picture A*).



Greenhouse Roof Vent Details



Appendix A – Truss

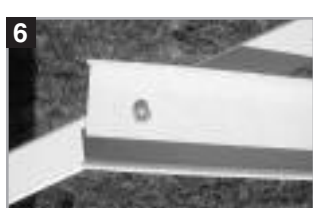

1. TRUSS ASSEMBLY

(This section is to be used only for greenhouses that are over 14' long.)

Trusses are usually installed after the sides, base, front, back and ridge are bolted together. Make sure that the greenhouse is temporarily braced (*see 4A on Aluminum Frame Assembly*).

- A. Lay the truss piece in the shape of an end wall.
- B. Slide the center pieces into the top of the truss and bolt them together. **1**, **2** and **3** (*lean to models do not have a center piece – see next page*).
- C. Slide the truss feet into the bottom of the truss and bolt them together. **4** and **5**.
- D. Bolt on the cross brace (*if required*) **6**.

2. TRUSS ASSEMBLY & INSTALLATION (IF REQUIRED)

The next step takes two people, one on each side. Carry the truss to the center of the greenhouse and put the feet on your foundation between the side base/sill **7**. Lift the top of the truss towards the ridge and bolt it on **8**. Use the notch on either side of the center. There are three notches in the ridge because if the glassbars have already been installed with the truss bracket facing one way, you can bolt the truss to either notch without having to turn the truss bracket around. Sometimes the installers put in all the glassbars first and slide the truss bracket in beforehand.

Remove the truss bracket from the truss. (*It may also be in a plastic bag.*) Unbolt the bar from the base. Slide the truss bracket into the bottom of the glassbar (*long bar*) **9** & **10** and slide it to the place where there is a 9/64" hole drilled into the truss. Fasten it with a screw. If the hole does not line up, you may have to drill a new hole in the truss bracket **11**. Do this after all the glass bars have been bolted together. To fasten the truss to the foundation, use 1/4" x 2" leg bolts.



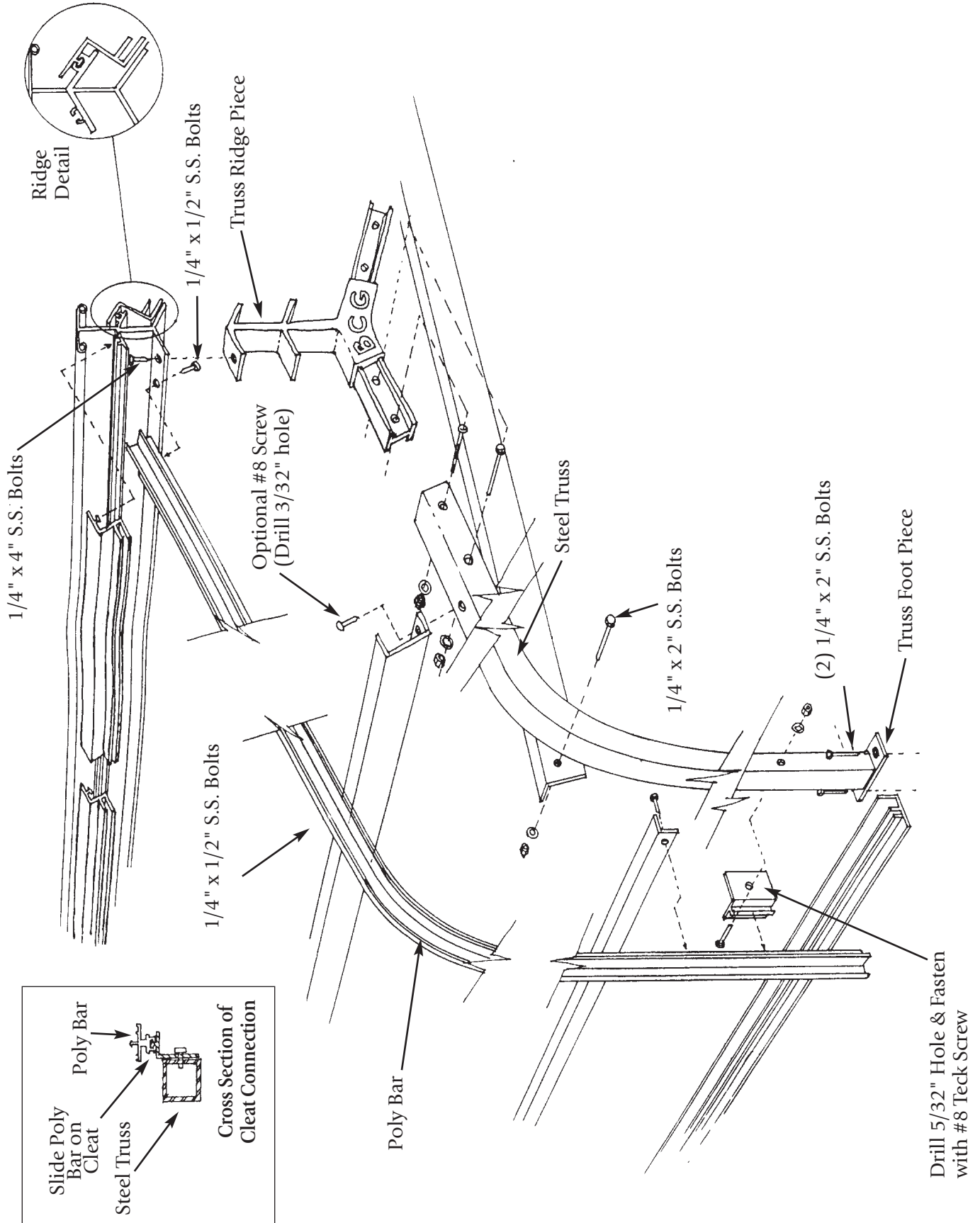

Appendix B – Vent Opener

INSTALLING THE BAYLISS AUTOMATIC VENT OPENERS

Detailed instructions are included in the box with the control (there are a few extra parts).

Use #8 stainless steel screws to fasten the Bayliss and the vent sill ① and the vent ②. All holes are already drilled.

After the Bayliss is fastened in place, install the threaded adjuster into the swivel block. This is made easier by lifting the vent with one hand until the piston rod only projects 1/2" through the swivel block.

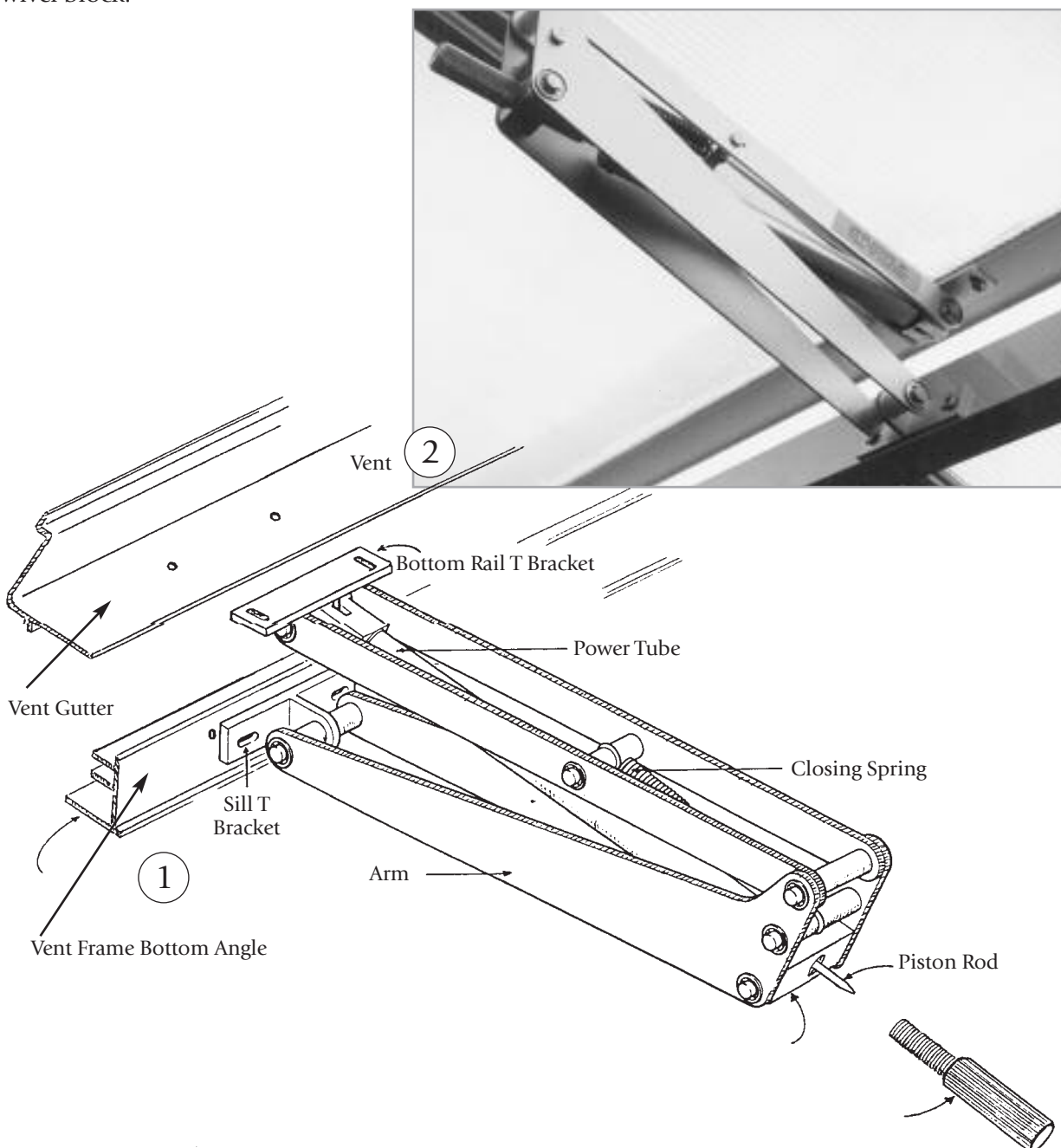

Appendix C – Motorized Intake Shutter

NOTE: Installation of the intake shutter is the same for a glass or polycarbonate greenhouse

- Slide bolts in through notches provided (*a small piece of foam stuffed in track under bolt keeps it from sliding down*).
- Ensure the blades open with flaps facing down.
- Install glass or polycarbonate on frame of intake shutter.
- Seal around the intake shutter after glass or polycarbonate is installed.

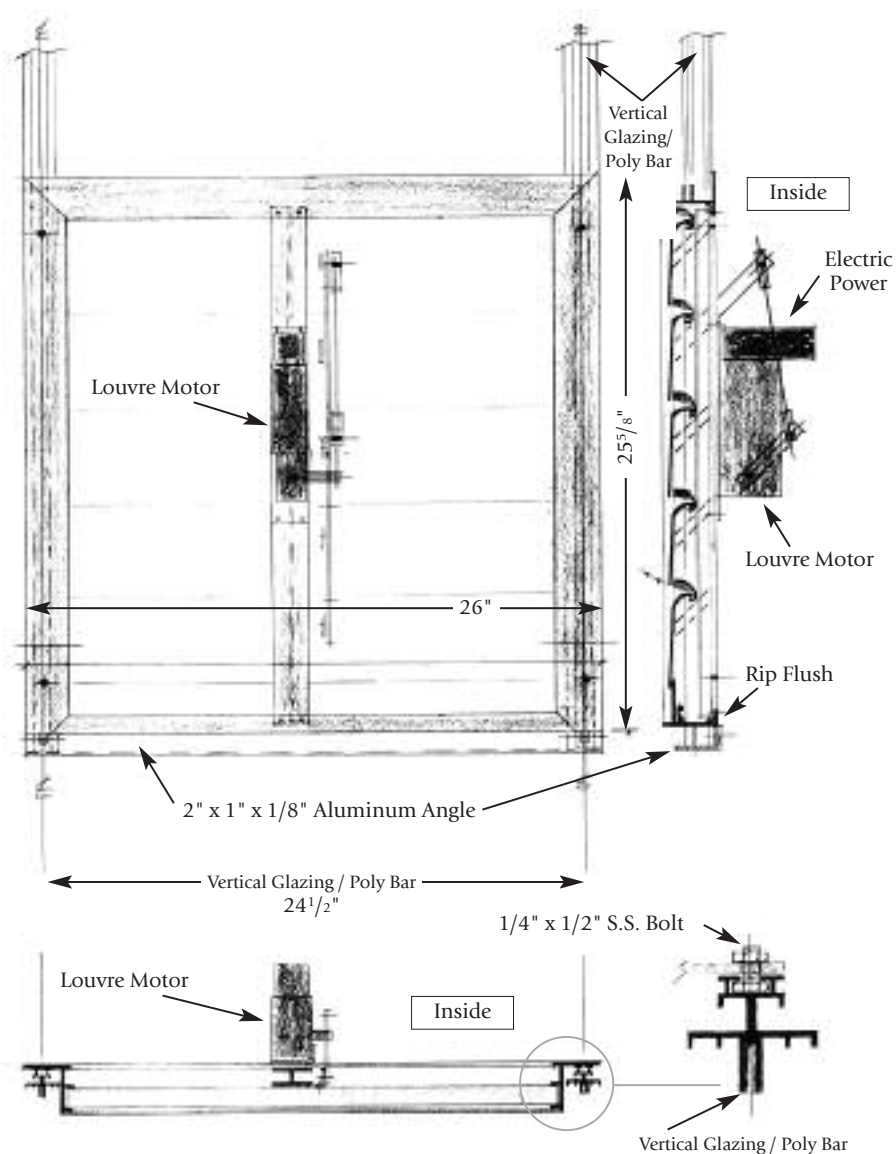

Inside View



Appendix D – Exhaust Fans

INTAKE SHUTTER ASSEMBLY

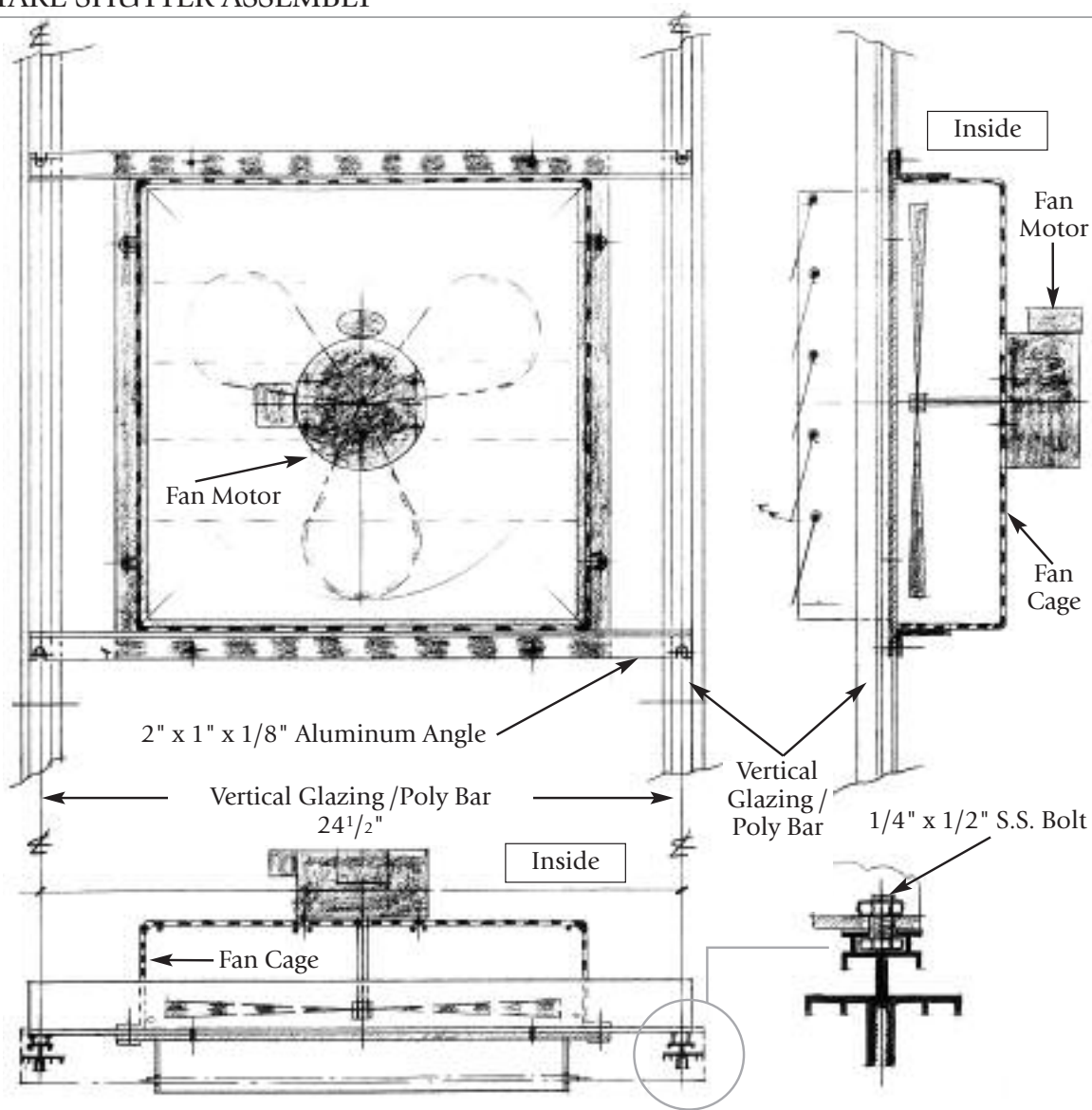

Appendix E – Side Vent

GLASS OR POLYCARBONATE SIDE VENT ASSEMBLY

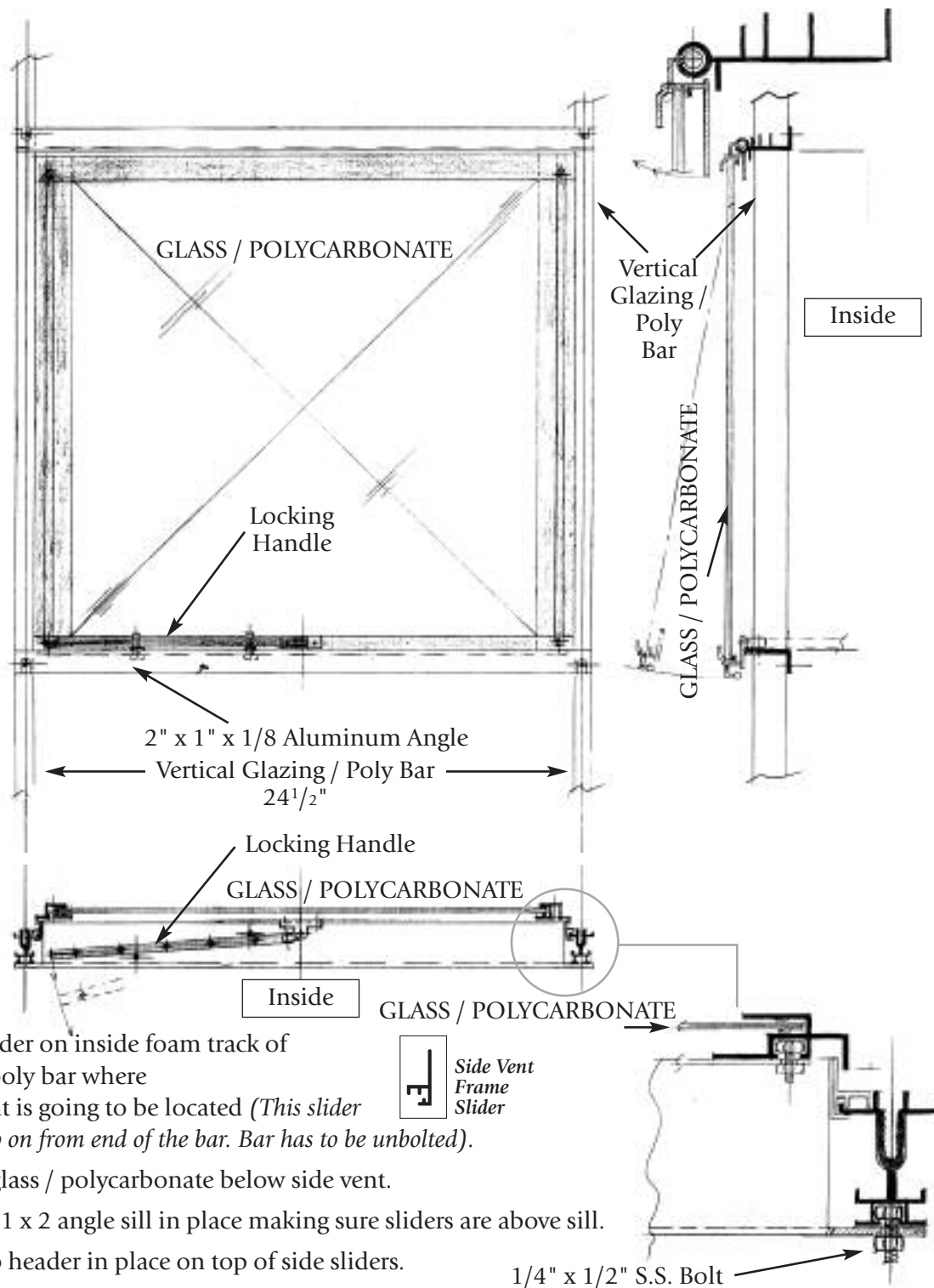

1. Slide slider on inside foam track of glass / poly bar where side vent is going to be located (*This slider has to go on from end of the bar. Bar has to be unbolted.*)
2. Install glass / polycarbonate below side vent.
3. Bolt on 1 x 2 angle sill in place making sure sliders are above sill.
4. Bolt top header in place on top of side sliders.
5. Slide vent into place.
6. Install automatic or manual opener.



1/4" x 1/2" S.S. Bolt

Appendix E – Side Vent CONTINUED



Appendix F – Glass Louvre

GLASS OR POLYCARBONATE GLASS LOUVRE ASSEMBLY





At this point, stand back and enjoy your workmanship.

*Your Evangeline Greenhouse
should now be closed in and ready for use.*

Congratulations!