

8. Polycarbonate Sheet Properties

• Strength and Insulation

Polygal sheets are designed with an "I-Beam" inner rib structure which gives them their extremely high structural strength, and air flutes which provide excellent thermal insulation. These twin features make Polygal sheets an excellent greenhouse covering solution for all areas, and are particularly suited for use in extreme climates.

• UV Protective Layer

The exterior side of each Polygal sheet features a special, co-extruded UV protective layer which prevents yellowing, ensures long-term light transmission quality, and protects the sheets and the contents of the greenhouse from UV damage. The UV protected side, marked by a printed protective film, should always be installed facing outwards.

• Anti-Fog Coating

The sheets' interior side is treated with Polygal's exclusive Anti-Fog coating - the most advanced system for preventing condensation drip damage available on the market. The Anti-Fog coated side of the sheet - marked by a white protective film - should always be installed facing inwards.

- Important! - Only remove the protective films immediately prior to installing the sheets. Once the protective coating is removed, make sure not to place the sheets on the ground, drag them or place them on any rough surface.

9. Polygal Sheet Specifications

Sheet thickness	Standard width	Weight (lb/ft ²)	Light transmission ASTM D1003 (%)	Minimum radius for cold bending arches	U-Factor winter night Btu(h.ft ² .°f)	
Standard	6	4', 6"	0.27	80	3', 5" (1.05)	0.63
	8	47.25", 48" 71.25", 72"	0.33	80	4', 7" (1.40)	0.60
	10	4', 6"	0.35	79	5', 9" (1.75)	0.53
Tripleclear	8	71.25"	0.39	77	For walls, windows and pitched roofs	0.50

10. Sheet Storage and Handling

- Sheets should be stored on a flat, clean surface and covered with a protective material (plastic sheeting, canvas, etc.). Do not cover sheets with soft PVC sheeting which can damage the sheets. Sheets to be stored for extended periods should be kept in an enclosed structure, well protected from rain, wind, dust and contact with hard objects. Smaller sheets can be placed on larger sheets, but larger sheets should never be placed on smaller ones.

- Careful compliance with these instructions will ensure fast and efficient installation and an attractive, professional finish.

- Never step on Polygal sheets - they can be extremely slippery, and are not designed to support a person's weight.

- Only use Polygal brand silicone which is especially manufactured for use with Polygal sheets.

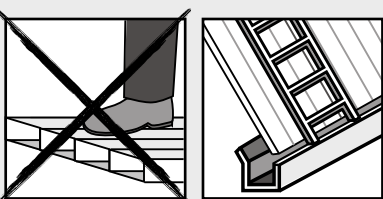
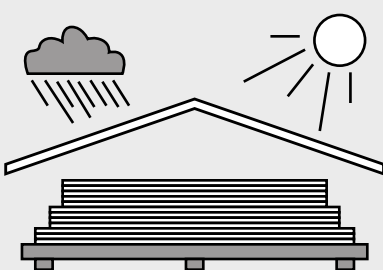
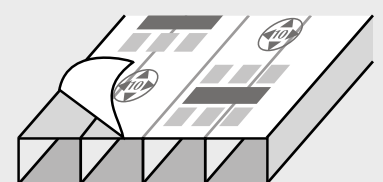
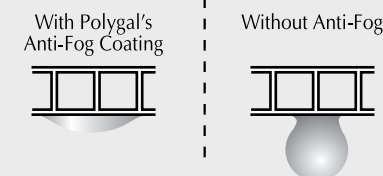

WARRANTY
Polygal Sheets (1/4" and above) are covered by a 10-year warranty covering colour, light transmission, strength and the AntiFog System. A warranty claim shall be considered valid only if the Polygal Limited Warranty Registration Card is completed and signed by the distributor on the date of sale.

The information in this document is intended for technical service and information purposes only. Polygal has undertaken to ensure that the information presented is accurate and reliable. Polygal and its representatives shall not be responsible for damage resulting from the use or installation of its product by greenhouse and roofing contractors or other persons.

POLYGAL USA Inc.
1227 Barberry Drive
Janesville WI 53545, U.S.A.
Tel: 1-608-757 1313; 1-800 537 0095
Fax: 1-608-757 1525
E-mail: sales@polygalusa.com
Web: www.polygalusa.com



2194 BRAND SHUMAN (Inst.Am - 02.2002.001)

Installation Instructions for Greenhouse Applications

Table of Contents

1. Distance between Purlins
2. Installation Guidelines
3. Determining Parallel Alignment of Sheets
4. Spacing Between Screws for Attaching Sheets
5. Elevating Sheets with Self-Adhesive Foam Spacers
6. Screws, Drilling and Screw Fastening
7. Profiles for Installing Greenhouse Coverings
8. Polygal Sheet Properties
9. Sheet Specifications
10. Storage and Handling

Polygal sheets are ideally suited as a greenhouse covering material, significantly improving the efficiency and profitability of greenhouse farming. Extra strong yet flexible and easy to install, with excellent thermal insulation and light transmission qualities as well as a host of other valuable features, Polygal sheets enable greenhouse farmers to maximize crop output while minimizing costs.

This manual includes important information for installing Polygal sheets as a greenhouse covering material. Greenhouse planning and design should always be performed by civil engineers or other certified professionals.

1. Recommended Distance between Purlins

Installing Polygal sheets with the correct distance between purlins is extremely important for proper, long-term performance of the sheets. Too large a distance between purlins can place excessive pressure on the sheets under extreme weather conditions.

For 6 and 8 mm thick sheets

Type of Application	Maximum Distance Between Purlins
Straight Walls	47.25" (1200 mm)
Pitched Roofs	47.25" (1200 mm)
Arched Roof with 29.5' (9.0m) radius	59" (1500 mm)
Windows or Fixed Panes	47.25" (1200 mm)

2. Installation Guidelines

Before installation, check that sheet dimensions conform to greenhouse plan layout. **In wall and gable applications, always ensure that the ribs are positioned vertically.**

Affix a U Profile (Polygal Cat. No. 212 for 6mm sheets - Polygal Cat. No. 213 for 8mm sheets) at the upper edge of the sheet, making sure that the short end is facing outwards. The length of this profile should be equal to the width of the sheet.

Polygal panels are supplied with either a colored sticker or a printed protective sheet indicating the exterior side of the panel, which should always be installed facing outwards.

Prepare profiles (Polygal Cat. No. 205 & 208 for 6mm sheets - Polygal Cat. No. 205 & 209 for 8mm sheets) for connecting between sheets. The profiles should be cut to the same length as the sheets.

Before removing the protective films from the sheets, peel back a corner of the film and make an identifying mark on the exterior side of the sheet with a permanent felt-tip marker. This will help ensure that the UV protected side of the sheet is installed in the correct outward position.

Remove the protective films only after the sheets have been positioned exactly where they will be installed. For wall sheets, remove the film before screwing the sheets to the sub-frame. Make sure to place the sheets so that the UV-protected exterior side is facing outwards.

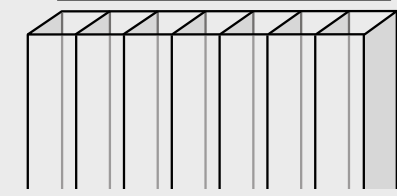
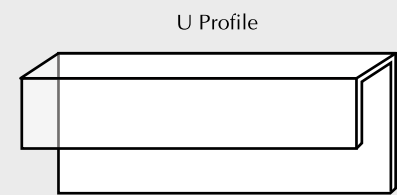
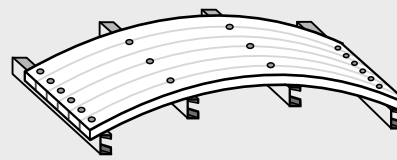
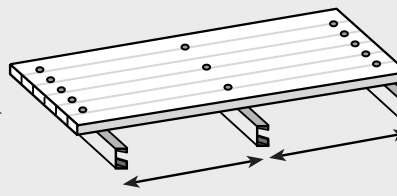
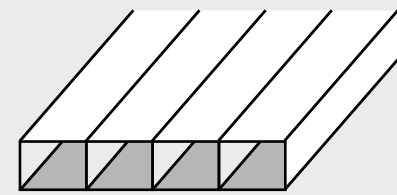

3. Determining Parallel Alignment of Sheets

In some cases the supporting poles, gables and rafters are perpendicular to sea level. The gutters and the ridge of the greenhouse (always parallel) must slope downwards to ensure proper drainage. Thus, the greenhouse roof surface is parallelogram-shaped and not a rectangular frame.

It is extremely important that all of the roofing sheets should be installed perpendicular to the gutter line. The outer two sheets should be cut according to the line of the gable. Under no circumstances should the panels be installed in line with the gable, which results in a sawtooth surface at the gutter.

The line where the roof and the gables meet should be covered using a metal angle fitting (see Section 7).

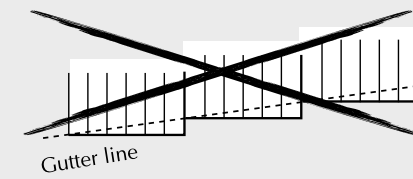
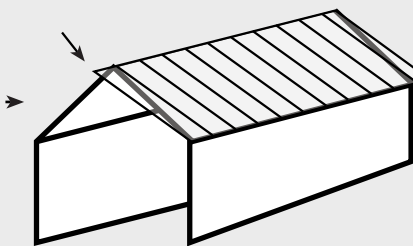

4. Recommended Spacing between Screws for Attaching Sheets.

Type of Application	Distance Between Screws
Full-size Sheets on purlins in roofs and walls	
- at edges of sheets	11.81" (30 cm)
- at intermediate purlins	15.75" (40 cm)
- at Ridge Profile	11.81" (30 cm)
- at Ridge Vent Frame	7.87" (20 cm)
Short Sheets for windows, gables, etc.....	11.81" (30 cm)
Arched Greenhouses with 16' to 30' (5.0 to 9.0 m) radius	
- at edges of sheets	7.87" (20 cm)
- at second purlin	11.81" (30 cm)
- at intermediate purlins	15.75" (40 cm)

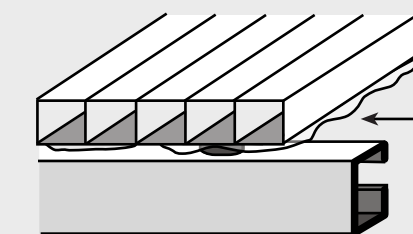
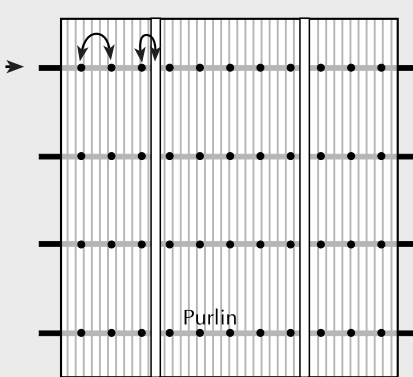

5. Elevating Sheets with Self-Adhesive Foam Spacers

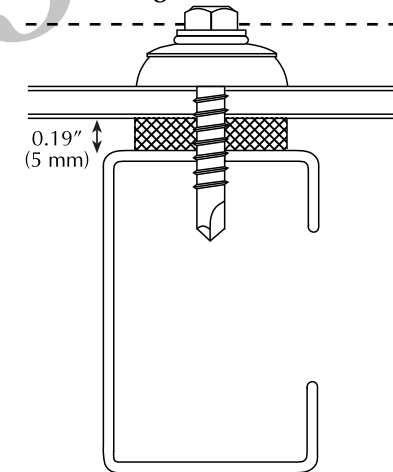

Before placing a sheet on the purlins, apply a spacer at least 0.19" (5 mm) thick (Polygal Cat. No. 505) on the purlins at the places where screws will be inserted. A spacer should be placed under every screw, to ensure proper drainage of condensed water above the purlins.

6. Screws, Drilling and Screw Fastening

For best results, always use Polygal screws and accessories, designed especially for use with Polygal sheets.

Polygal's EPDM Gaskets and Metal Washers (Polygal Cat. No.473), together with Polygal's Self-Drilling Screws provide a high-performance, trouble-free fastening system, with highly effective dual point sealing between the EPDM gasket and the screw, and between the screw head and metal washer. It is strongly recommended to use self-drilling, special-coated, corrosion-resistant screws (Polygal Cat. No.411=1/4"X1", 412=1/4"X1 1/4", 413=1/4"X 1 1/2").

Care should be taken when drilling to ensure that the screws are inserted perpendicularly to the sheet (as in example "b").

To avoid excess pressure on the sheets when tightening screws, ensure that drilling stops when the gasket is compressed 0.04" - 0.06" (1 - 1.5 mm) against the panel. Alternately, a "deep locator" drill can be used. Overcompression places excess stress on the panel and may cause damage.

7. Polycarbonate Profiles for Connecting Between Sheets

Polygal sheets should be connected using a base profile (Polygal Cat. No.205) and a cap profile (Polygal Cat. No.208 for 6mm sheets and No. 209 for 8/10mm sheets). The length of the connecting profiles should be the same as the length of the sheets.

For trimming the sheets' upper edges (in roofs, gables, and walls), U profiles (Polygal Cat. No. 212, 213, 214) should be used.

For trimming the sheets' lower edges in walls, U profiles are not always necessary, but metal edging is highly recommended.

Most greenhouses will require an aluminium profile on the ridge which serves as a hinge for roof windows and as glazing rebate.

A galvanized metal angle fitting 3.94" x 3.94" (100 x 100mm) and at least 0.08" (2 mm) thick should be installed to support the sheet edges in the corners of the structure, the walls, and in attaching the roof surface to the gables.

A similar 0.022" (0.55 mm) thick galvanized metal angle fitting should be installed for trimming the external edges.

The sheet edges can also be trimmed using AntiDust Tape (Filter or Closed). Filter AntiDust Tape (Polygal Cat. No. 508, 509, 510) is intended for trimming the lower edge of the sheet, where the porous tape allows drainage of condensed moisture. Closed AntiDust Tape (Polygal Cat. no. 512, 513, 514) is intended for trimming the upper edge of the sheet. Where AntiDust Tape is used, trimming cover should be installed to protect the tape from exposure to sun and moisture.

